



# Bulletin Officiel de la Propriété Industrielle (BOPI)

PUBLICATION N° 07DM / 2026  
du 03 Juin 2026

**Dessins et Modèles  
Industriels**

[www.oapi.int](http://www.oapi.int)

**SOMMAIRE**

<b>TITRES</b>	<b>PAGES</b>
<b>PARTIE I : GENERALITES</b>	<b>2</b>
Extrait de la norme ST3 de l'OMPI utilisée pour la représentation des pays et organisations internationales	3
Extrait de la norme ST.80 de l'OMPI utilisée en matière de documentation de Dessins et Modèles Industriels	7
Classification Internationale des Dessins et Modèles Industriels en vertu de l'Arrangement de LOCARNO du 08 Octobre 1968 (13 <sup>ème</sup> édition)	8
Clarification du Règlement relatif à l'Extension des Droits suite à une nouvelle Adhésion à l'Accord de Bangui	10
Adresses utiles	11
<b>PARTIE II</b>	<b>12</b>
Demandes des dessins et modèles industriels selon l'Accord de Bangui, Acte de 2015	13
<b>PARTIE III</b>	<b>69</b>
Enregistrement des dessins et modèles industriels selon l'Accord de Bangui, Acte de 1999	69
<b>PARTIE IV</b>	<b>70</b>
Enregistrement des dessins et modèles industriels selon l'Accord de Bangui, Acte de 2015	71
<b>PARTIE V</b>	<b>101</b>
Rejets des demandes d'enregistrement des dessins et modèles industriels	101
<b>PARTIE VI</b>	<b>102</b>
Prolongation des dessins et modèles industriels	102
<b>PARTIE VII</b>	<b>103</b>
Inscriptions au registre spécial des dessins et modèles industriels	103
<b>PARTIE VIII</b>	<b>104</b>
Extension des droits	104
<b>PARTIE IX</b>	<b>105</b>
Radiations	105
<b>PARTIE X</b>	<b>106</b>
Errata des Demandes d'enregistrement des dessins et modèles industriels selon l'Accord de Bangui, Acte de 2015	106
<b>PARTIE XI</b>	<b>107</b>
Errata des enregistrements des dessins et modèles industriels	107

**PARTIE I  
GENERALITES**

## Extrait de la norme ST.3 de l'OMPI

Code normalisé à deux lettres recommandé pour la représentation des pays ainsi que d'autres entités et des organisations internationales délivrant ou enregistrant des titres de propriété industrielle.

Afghanistan	AF	Cook, Îles	CK
Afrique du Sud	ZA	Corée(République de Corée)	KR
Albanie	AL	Corée (Rép. Populaire de Corée)	KP
Algérie	DZ	Costa Rica	CR
Allemagne	DE	Côte d'Ivoire*	CI
Andorre	AD	Croatie	HR
Angola	AO	Cuba	CU
Anguilla	AI	Danemark	DK
Antigua-et-Barbuda	AG	Djibouti	DJ
Antilles Néerlandaises	AN	Dominicaine, République	DO
Arabie Saoudite	SA	Dominique	DM
Argentine	AR	Egypte	EG
Arménie	AM	El Salvador	SV
Aruba	AW	Emirats Arabes Unis	AE
Australie	AU	Equateur	EC
Autriche	AT	Erythrée	ER
Azerbaïdjan	AZ	Espagne	ES
Bahamas	BS	Estonie	EE
Bahreïn	BH	Etats-Unis d'Amérique	US
Bangladesh	BD	Ethiopie	ET
Barbade	BB	Ex Rep. Yougoslavie de Macedoine	MK
Bélarus	BY	Falkland, Îles (Malvinas)	FK
Belgique	BE	Fédération de Russie	RU
Belize	BZ	Féroé, Îles	FO
Bénin*	BJ	Fidji	FJ
Bermudes	BM	Finlande	FI
Bhoutan	BT	France	FR
Bolivie	BO	Gabon*	GA
Bonaire, Saint-Eustache et Saba	BQ	Gambie	GM
Bosnie-Herzégovine	BA	Géorgie	GE
Botswana	BW	Géorgie du Sud et les Îles SandwichduSud	GS
Bouvet, Île	BV	Ghana	GH
Brésil	BR	Gibraltar	GI
Brunéi Darussalam	BN	Grèce	GR
Bulgarie	BG	Grenade	GD
Burkina Faso*	BF	Groenland	GL
Burundi	BI	Guatemala	GT
Caïmanes, Îles	KY	Guernesey	GG
Cambodge	KH	Guinée*	GN
Cameroun*	CM	Guinée-Bissau*	GW
Canada	CA	GuinéeEquatoriale*	GQ
Cap-Vert	CV	Guyana	GY
Centrafricaine, République*	CF	Haïti	HT
Chili	CL	Honduras	HN
Chine	CN	Hong Kong	HK
Chypre	CY	Hongrie	HU

Colombie	<b>CO</b>	Île de Man	<b>IM</b>
Comores*	<b>KM</b>	Îles Vierges (Britanniques)	<b>VG</b>
Congo*	<b>CG</b>	Inde	<b>IN</b>
Congo(Rép.Démocratique)	<b>CD</b>	Indonésie	<b>ID</b>
Iran(République Islamique d')	<b>IR</b>	Norvège	<b>NO</b>
Iraq	<b>IQ</b>	Nouvelle-Zélande	<b>NZ</b>
Irlande	<b>IE</b>	Oman	<b>OM</b>
Islande	<b>IS</b>	Ouganda	<b>UG</b>
Israël	<b>IL</b>	Ouzbékistan	<b>UZ</b>
Italie	<b>IT</b>	Pakistan	<b>PK</b>
Jamaïque	<b>JM</b>	Palaos	<b>PW</b>
Japon	<b>JP</b>	Panama	<b>PA</b>
Jersey	<b>JE</b>	Papouasie-Nouvelle-Guinée	<b>PG</b>
Jordanie	<b>JO</b>	Paraguay	<b>PY</b>
Kazakhstan	<b>KZ</b>	Pays-Bas	<b>NL</b>
Kenya	<b>KE</b>	Pérou	<b>PE</b>
Kirghizistan	<b>KG</b>	Philippines	<b>PH</b>
Kiribati	<b>KI</b>	Pologne	<b>PL</b>
Koweït	<b>KW</b>	Portugal	<b>PT</b>
Laos	<b>LA</b>	Qatar	<b>QA</b>
Lesotho	<b>LS</b>	Région admin. Spéciale de Hong Kong (Rep. Populaire de Chine)	<b>HK</b>
Lettonie	<b>LV</b>	Roumanie	<b>RO</b>
Liban	<b>LB</b>	Royaume Uni (Grande Bretagne)	<b>GB</b>
Libéria	<b>LR</b>	Rwanda	<b>RW</b>
Libye	<b>LY</b>	Sahara Occidental	<b>EH</b>
Liechtenstein	<b>LI</b>	Saint-Kitts-et-Nevis	<b>KN</b>
Lituanie	<b>LT</b>	Saint-Marin	<b>SM</b>
Luxembourg	<b>LU</b>	Saint-Marin (Partie Néerlandaise)	<b>SX</b>
Macao	<b>MO</b>	Saint-Siège(Vatican)	<b>VA</b>
Macédoine	<b>MK</b>	Saint-Vincent-et-les Grenadines(a,b)	<b>VC</b>
Madagascar	<b>MG</b>	Sainte-Hélène	<b>SH</b>
Malaisie	<b>MY</b>	Sainte-Lucie	<b>LC</b>
Malawi	<b>MW</b>	Salomon,Îles	<b>SB</b>
Maldives	<b>MV</b>	Samoa	<b>WS</b>
Mali*	<b>ML</b>	SaoTomé-et-Principe	<b>ST</b>
Malte	<b>MT</b>	Sénégal*	<b>SN</b>
Mariannes du Nord,Îles	<b>MP</b>	Serbie	<b>RS</b>
Maroc	<b>MA</b>	Seychelles	<b>SC</b>
Maurice	<b>MU</b>	Sierra Leone	<b>SL</b>
Mauritanie*	<b>MR</b>	Singapour	<b>SG</b>
Mexique	<b>MX</b>	Slovaquie	<b>SK</b>
Moldova	<b>MD</b>	Slovénie	<b>SI</b>
Monaco	<b>MC</b>	Somalie	<b>SO</b>
Mongolie	<b>MN</b>	Soudan	<b>SD</b>
Monténégro	<b>ME</b>	SriLanka	<b>LK</b>
Montserrat	<b>MS</b>	Suède	<b>SE</b>
Mozambique	<b>MZ</b>	Suisse	<b>CH</b>
Myanmar(Birmanie)	<b>MM</b>	Suriname	<b>SR</b>

Namibie	NA	Swaziland	SZ
Nauru	NR	Syrie	SY
Népal	NP	Tadjikistan	TJ
Nicaragua	NI	Taiwan, Province de Chine	TW
Niger*	NE	Tanzanie (Rép.-Unie)	TZ
Nigéria	NG	Tchad*	TD
Thaïlande	TH	Tchèque, République	CZ
Timor Oriental	TP	Ukraine	UA
Togo*	TG	Uruguay	UY
Tonga	TO	Vanuata	VU
Trinité-et-Tobago	TT	Venezuela	VE
Tunisie	TN	VietNam	VN
Turkménistan	TM	Yémen	YE
Turks et Caïques, îles	TC	Yougoslavie	YU
Turquie	TR	Zambie	ZM
Tuvalu	TV	Zimbabwe	ZW

**ORGANISATIONS INTERNATIONALES DELIVRANT OU ENREGISTRANT DES TITRES DE PROPRIETE INDUSTRIELLE**

Bureau Benelux des marques et des dessins et modèles industriels	BX
Office Communautaire des Variétés Végétales (Communauté Européenne) (OCVV)	QZ
Office de l'Union Européenne pour la Propriété Intellectuelle (EUIPO) (Marques, dessins et modèles)	EM
Office des Brevets du conseil de Coopération des Etats du Golfe (CCG)	GC
Office Européen des Brevets (OEB)	EP
Organisation Mondiale de la Propriété Intellectuelle (OMPI)	WO
Bureau International de l'OMPI	IB
Organisation Africaine de la Propriété Intellectuelle (OAPI)	OA
Organisation Eurasienne des Brevets (OEAB)	EA
Organisation Régionale Africaine de la Propriété Industrielle (ARIPO)	AP

\*Etats membres de l'OAPI

**CODES UTILISES EN MATIERE D'INSCRIPTIONS DANS LE REGISTRE SPECIAL DES MARQUES DE PRODUITS OU DE SERVICES ET DES DESSINS OU MODELES INDUSTRIELS**

- (1) Numéro d'enregistrement.
- (2) Numéro de dépôt ou de procès-verbal.
- (3) Nature de l'inscription.
- (4) Nom du bénéficiaire de l'inscription, nouvelle adresse ou dénomination, etc.
- (5) Le(s) numéro(s) de l'inscription.
- (6) Date(s) d'inscription.

**CODES UTILISES EN MATIERE DE DOCUMENTATION DE DESSINS ET MODELES INDUSTRIELS**

- (11) Numéro d'enregistrement.
- (21) Numéro de dépôt ou de P.V.
- (22) Date de dépôt.
- (30) Priorité(s): Date(s), pays (code de la norme ST.3 de l'OMPI) et numéro(s).
- (51) Classification internationale des dessins et modèles industriels  
(Classification de LOCARNO).
- (54) Désignation précise de(s) produit(s) au(x) quel(s) le(s) dessin(s) ou modèle(s) industriel(s) est (sont) destiné(s) à être incorporés : Titre du (des) dessin(s) ou modèle(s) industriel(s)
- (55) Reproduction du dessin ou modèle industriel (par exemple, dessin, photographie).
- (71) Nom(s) et adresse(s) du (des) déposant(s).
- (72) Nom(s) et adresse(s) du (des) créateur(s) de(s) dessin(s) ou modèle(s) industriel(s).
- (74) Nom et adresse du mandataire.
- ( ) Division de la demande (demande divisionnaire)

**CODES UTILISES EN MATIERE DE DESSINS ET MODELES INDUSTRIELS RENOUVELES**

- (1) Numéro d'enregistrement.
- (2) Numéro et date de dépôt.
- (3) Classe(s) internationale(s).
- (4) Titre du (des) dessin(s) ou modèle(s) industriel(s).
- (5) Nom(s) et adresse(s) du (des) déposant(s).
- (6) Nom(s) et adresse(s) du (des) créateur(s).
- (7) Numéro du renouvellement.
- (8) Nom et adresse du mandataire.

## CLASSIFICATION INTERNATIONALE POUR LES DESSINS ET MODELES INDUSTRIELS

ETABLIE EN VERTU DE L'ARRANGEMENT DE LOCARNO DU 8 OCTOBRE 1968 (13<sup>ème</sup> ÉDITION)

- Classe 1 Produits alimentaires:** Boulangerie, biscuits, pâtisserie, pâtes et autres produits à base de céréales, chocolats, confiserie, glaces; fruits et légumes; fromages, beurre et succédanés du beurre, autres produits laitiers; produits de boucherie, de charcuterie et de poissonnerie; tofu et produits de tofu; aliments pour animaux; divers.
- Classe 2 Articles d'habillement et mercerie:** Sous-vêtements, lingerie, corsets, soutiens-gorge, vêtements de nuit; vêtements; articles de chapellerie; chaussures, bas et chaussettes; cravates, écharpes, foulards et mouchoirs; ganterie; mercerie et accessoires d'habillement; divers.
- Classe 3 Articles de voyages, étuis, parasols et objets personnels, non compris dans d'autres classes :** Malles, valises, serviettes, sacs à main, porte-clés, étuis adaptés à leur contenu, portefeuilles et articles analogues; parapluies, parasols, ombrelles et cannes; éventails; dispositifs pour transporter et marcher avec des bébés et des enfants.
- Classe 4 Brosserie:** Brosses, pinceaux et balais de nettoyage; brosses et pinceaux de toilette, brosses pour vêtements et brosses à chaussures; brosses pour machines; brosses et pinceaux à peindre, pinceaux pour cuisiner; divers.
- Classe 5 Articles textiles non confectionnés, feuilles de matière artificielle ou naturelle :** Filés, dentelles; broderies; rubans, galons et autres articles de passementerie; tissus et étoffes; feuilles de matière artificielle ou naturelle; divers.
- Classe 6 Ameublement :** Lits et sièges; tables et meubles; meubles de rangement; meubles combinés; autres pièces de mobilier et parties de meubles; miroirs et cadres; cintres; matelas et coussins; rideaux et stores intérieurs; tapis de sol, paillasons et carpettes; tapisseries; couvertures, linge de maison et de table; divers.
- Classe 7 Articles de ménage non compris dans d'autres classes:** Vaisselle et verrerie; appareils, ustensiles et récipients pour la cuisson; couverts de table; appareils et ustensiles, actionnés manuellement, pour préparer la nourriture ou les boissons; fers à repasser, ustensiles pour laver, nettoyer ou sécher; autres ustensiles de table; autres récipients de ménage; accessoires de cheminée d'appartement; supports pour appareils et ustensiles ménagers; dispositifs de refroidissement et de congélation et conteneurs isothermes; divers.
- Classe 8 Outils et quincaillerie:** Outils et instruments servant à forer, à fraiser ou à creuser; marteaux, outils et instruments analogues; outils et instruments tranchants; tournevis, outils et instruments analogues; poignées, boutons et gonds; dispositifs de verrouillage ou de fermeture. Moyens de fixation, de soutien ou de montage, non compris dans d'autres classes; râteliers à bicyclettes et motocyclettes; quincaillerie pour rideaux; divers.
- Classe 9 Emballages et récipients pour le transport ou la manutention des marchandises:** Bouteilles, flacons, pots, bonbonnes, récipients munis d'un système à pression; bidons et fûts; boîtes, caisses, conteneurs, boîtes à conserves; cageots et paniers; sacs, sachets, tubes et capsules; cordes et matériaux de cerclage; moyens de fermeture et accessoires; palettes et plates-formes de manutention; poubelles et conteneurs pour ordures et leurs supports; poignées pour le transport ou la manutention de colis et conteneurs; divers.
- Classe 10 Horlogerie et autres instruments de mesure, instruments de contrôle ou de signalisation :** Horloges, pendules et réveils; montres et montres-bracelets; autres instruments de mesure du temps; autres instruments, appareils et dispositifs de mesure; instruments, appareils et dispositifs de contrôle, de sécurité ou d'essai; appareils et dispositifs de signalisation; boîtes, boîtiers, cadrans, aiguilles et toutes les autres pièces et accessoires d'instruments de mesure, de contrôle ou de signalisation; divers.
- Classe 11 Objets d'ornement:** Bijouterie et joaillerie; bibelots, ornements de table, de dessus de cheminée ou de mur, vases et pots à fleurs; médailles et insignes; fleurs, plantes et fruits artificiels; drapeaux, articles de décoration de fête; divers.
- Classe 12 Moyens de transport ou de levage :** Véhicules à traction animale; chariots à main, brouettes; locomotives et matériel roulant pour les chemins de fer et tous autres véhicules sur rail; téléphériques, télésièges et remonte-pentes; élévateurs, appareils de levage ou de manutention; navires et bateaux; avions et autres véhicules aériens ou spatiaux; automobiles, autobus et camions; tracteurs; remorques et véhicules routiers; cycles et motocycles; voitures d'enfant, fauteuils roulants pour infirmes, brancards; véhicules à usages spéciaux; autres véhicules; pneus, bandages et chaînes antidérapantes pour véhicules; parties, équipements et accessoires de véhicules, non compris dans d'autres classes ou sous-classes; composants de l'infrastructure ferroviaire; divers.
- Classe 13 Appareils de production, de distribution ou de transformation de l'énergie électrique :** Générateurs et moteurs; transformateurs, redresseurs, piles et accumulateurs; matériel de distribution ou de commande d'énergie électrique; équipement solaire; divers.
- Classe 14 Appareils d'enregistrement, de télécommunication ou de traitement de l'information :** Appareils d'enregistrement ou de reproduction de sons ou d'images; appareils pour le traitement de l'information ainsi que les appareils et dispositifs périphériques; appareils de télécommunication et de télécommande sans fil, amplificateurs-radios; interfaces et icônes; supports d'enregistrement et de stockage de données; supports pour équipement électronique, non compris dans d'autres classes; divers.
- Classe 15 Machines non comprises dans d'autres classes:** Moteurs; pompes et compresseurs; machines agricoles et sylvicoles; machines

pour bâtir et pour l'exploitation minière; machines pour laver, nettoyer ou sécher; machines textiles, machines à coudre, à tricoter ou à broder, y compris leurs parties intégrantes; machines et appareils de réfrigération; machines-outils, machines à abraser, machines de fonderie ; machines pour le remplissage, le conditionnement ou l'emballage ; divers.

- Classe 16** **Articles de photographie, de cinématographie ou d'optique:** Appareils pour photographier ou filmer; appareils de projection et visionneuses; appareils pour photocopier ou agrandir; appareils et ustensiles pour le développement; accessoires; articles d'optique ; divers.
- Classe 17** **Instruments de musique :** Instruments à clavier; instruments à vent; instruments à cordes; instruments à percussion; instruments mécaniques ; divers.
- Classe 18** **Imprimerie et machines de bureau :** Machines à écrire ou à calculer; machines pour l'impression; caractères et signes typographiques; machines à relier, agrafeuses d'imprimerie, massicots ; divers.
- Classe 19** **Papeterie, articles de bureau, matériel pour artistes ou d'enseignement:** Papier à écrire, cartes de correspondance et faire-part; articles de bureau; calendriers; livres, cahiers et objets d'aspect extérieur semblable; matériel et instruments pour écrire à la main, pour dessiner, pour peindre, pour sculpter, pour graver ou pour d'autres techniques artistiques; matériel et appareils d'enseignement; autres imprimés ; divers.
- Classe 20** **Équipement de vente ou de publicité, signes indicateurs:** Distributeurs automatiques; matériel d'exposition ou de vente; signes indicateurs, dispositifs publicitaires ; divers.
- Classe 21** **Jeux, jouets, tentes et articles de sport:** Jeux et jouets; appareils et articles de gymnastique ou de sport; autres articles d'amusement et de divertissement; tentes et accessoires ; divers.
- Classe 22** **Armes, articles pyrotechniques, articles pour la chasse, la pêche et la destruction d'animaux nuisibles:** Armes à projectiles; autres armes; munitions, fusées et articles pyrotechniques; cibles et accessoires; articles pour la chasse ou la pêche; pièges, articles pour la destruction d'animaux nuisibles ; divers.
- Classe 23** **Installations pour la distribution de fluides, installations sanitaires, de chauffage, de ventilation ou de conditionnement d'air, combustibles solides:** Installations pour la distribution de fluides; équipements pour le chauffage; ventilation et conditionnement d'air; combustibles solides ; installations sanitaires d'hygiène personnelle ; équipements pour uriner et déféquer ; autres équipements et accessoires sanitaires non compris dans d'autres classes ou sous-classes ; divers.
- Classe 24** **Médecine et laboratoires:** Appareils et installations pour médecins, hôpitaux ou laboratoires, instruments médicaux, instruments et ustensiles de laboratoire; prothèses; articles de pansement, de bandage et de soins médicaux ; divers.
- Classe 25** **Constructions et éléments de construction:** Matériaux de construction; parties de construction préfabriquées ou préassemblées; maisons, garages et autres constructions; escaliers, échelles et échafaudages ; divers.
- Classe 26** **Appareils d'éclairage:** Bougeoirs et chandeliers; torches, lampes et lanternes portatives; appareils d'éclairage public; sources lumineuses, électriques ou non; lampes, lampadaires, lustres, appliques murales ou de plafond, abat-jour, réflecteurs, lampes pour projecteurs de photographie ou de cinématographie; dispositifs lumineux de véhicules ; divers.
- Classe 27** **Tabacs et articles pour fumeurs:** Tabacs, cigares et cigarettes; pipes, fume-cigares et fume-cigarettes; cendriers; allumettes; briquets; étuis à cigares, étuis à cigarettes, tabatières et pots à tabac ; cigarettes électroniques et autres articles pour fumeurs de cigarettes électroniques ; divers.
- Classe 28** **Produits pharmaceutiques ou cosmétiques, articles et équipements de toilette :** Produits pharmaceutiques; produits cosmétiques; articles de toilette et équipements pour soins de beauté; perruques et articles de beauté postiches ; rafraîchisseurs d'air ; divers.
- Classe 29** **Dispositifs et équipements contre le feu, pour la prévention d'accidents ou le sauvetage :** Dispositifs et équipements contre le feu; dispositifs et équipements pour la prévention d'accidents ou le sauvetage, non compris dans d'autres classes ; divers.
- Classe 30** **Articles pour les soins et l'entretien des animaux :** Vêtements pour animaux; enclos, cages, niches et abris analogues; nourrisseurs et abreuvoirs; sellerie; fouets et aiguillons; couchettes, nids et mobilier pour animaux ; perchoirs et autres accessoires de cages; marqueurs, marques et entraves; poteaux d'attache ; articles de toilettage pour animaux ; bacs à litières et dispositifs d'enlèvement des excréments d'animaux ; jouets pour animaux ; divers.
- Classe 31** **Machines et appareils pour préparer la nourriture ou les boissons, non compris dans d'autres classes:** Machines et appareils pour préparer la nourriture et les boissons, non compris dans d'autres classes.
- Classe 32** **Symboles graphiques et logos, motifs décoratifs pour surfaces, ornementation:** Symboles graphiques et logos, motifs décoratifs pour surfaces, ornementation.

**CLARIFICATION DU REGLEMENT RELATIF A L'EXTENSION DES DROITS  
SUITE A UNE NOUVELLE ADHESION A L'ACCORD DE BANGUI**

**RESOLUTION N°47/32**

**LE CONSEIL D'ADMINISTRATION  
DE L'ORGANISATION AFRICAINE DE LAPROPRIETE INTELLECTUELLE**

Vu L'accord portant révision de l'accord de Bangui du 02 Mars 1977 instituant une Organisation Africaine de la Propriété Intellectuelle et ses annexes ;

Vu Les dispositions des articles 18 et 19 dudit Accord relatives Aux attributions et pouvoirs du Conseil d'Administration ;

**ADOPTE** la clarification du règlement du 04 décembre 1988 relatif à l'extension des droits suite à une nouvelle adhésion à l'Accord de Bangui ci-après :

**Article 1er** :

Le Règlement du 04 décembre 1988 relatif à l'extension des droits suite à une nouvelle adhésion à l'Accord de Bangui est réaménagé ainsi qu'il suit :

**«Article 5 (nouveau)** :

Les titulaires des titres en vigueur à l'Organisation avant la production des effets de l'adhésion d'un Etat à l'accord de Bangui ou ceux dont la demande a été déposée avant cette date et qui voudront étendre la protection dans ces Etats doivent formuler une demande d'extension à cet effet auprès de l'Organisation suivant les modalités fixées aux articles 6 à 18 ci-dessous.

Le renouvellement de la protection des titres qui n'ont pas fait l'objet d'extension avant l'échéance dudit renouvellement entraîne une extension automatique des effets de la protection à l'ensemble du territoire OAPI».

Le reste sans changement.

**Article 2** :

La présente clarification, qui entre en vigueur à compter du 1<sup>er</sup> janvier 2008, s'applique aussi aux demandes d'extension en instance et sera publiée au Bulletin Officiel de l'Organisation.

Fait à Bangui le 17 décembre 2007

## Siège social

Place de la Préfecture  
B.P. 887 Yaoundé - Cameroun  
Tél.: (237) 222 20 57 00  
Site web : [www.oapi.int](http://www.oapi.int) / Email : [oapi@oapi.int](mailto:oapi@oapi.int)

### ADRESSES DES STRUCTURES NATIONALES DE LIAISON AVEC L'OAPI (SNL)

#### BENIN - Cotonou

Agence Nationale de la Propriété Industrielle (ANAPI)

01 B.P. 363 Cotonou 01  
Tél.: (229) 21 31 02 40  
Fax.: (229) 21 30 30 24

(Ministère de l'Industrie, du Commerce et des PME)

#### BURKINA FASO - Ouagadougou

Centre National de la Propriété Industrielle (CNPI)

04 B.P. 382 Ouagadougou 04  
Tél.: (226) 50 30 09 41/25 31 03 11  
Fax.: (226) 50 33 05 63

(Ministère de l'Industrie, du Commerce et de l'Artisanat)

#### CAMEROUN - Yaoundé

Direction du Développement Technologique et de la Propriété Industrielle

B.P.: 1652 Yaoundé  
Tél.: (237) 222 20 37 78  
Fax.: (237) 222 20 37 38

(Ministère des Mines, de l'Industrie et du Développement Technologique)

#### CENTRAFRIQUE - Bangui

Direction de la Propriété Industrielle

Avenue B. BOGANDA  
B.P. : 1988 Bangui  
Tél. : (236) 21 61 17 44  
Fax: (236) 21 61 76 53

(Ministère du Commerce et de l'Industrie)

#### COMORES - Moroni

Office comorien de la propriété intellectuelle

B.P. 41 Moroni  
Tél : (269) 33 10 703  
Fax : (269) 775 00 03/33 35 360

(Ministère de la production, de l'environnement, de l'énergie, de l'industrie et de l'artisanat)

#### CONGO - Brazzaville

Direction de l'antenne Nationale de la Propriété Industrielle (DANPI)

B.P. 72 Brazzaville  
Tel (242) 581 56 57/581 54 80  
Fax : (242) 22 81 32 12

(Ministère du Développement Industriel et de la Promotion du Secteur Privé)

#### COTE D'IVOIRE - Abidjan

Office Ivoirien de la Propriété Industrielle (OIIPI)

01 B.P. 2337 Abidjan  
Tél. : (225) 22 41 16 65  
Fax: (225) 22 41 11 81

(Ministère de l'Industrie)

#### GABON - Libreville

Office Gabonais de la Propriété Industrielle (OGAPI)

B.P. 1025 Libreville  
Tél. : (241) 01 74 59 24/04 13 71 88  
Fax. : (241) 01 76 30 55

(Ministère de l'Industrie et des Mines)

#### GUINEE - Conakry

Service National de la Propriété Industrielle et de l'Innovation Technologique

B.P. 13 Conakry - GUINEE  
Tél.: (224) 21 31 02 15/21 32 11 51/21 31 46 08  
Fax : (224) 21 31 46 08

(Ministère de l'Industrie, du Commerce et des PME)

#### GUINEE BISSAU - Bissau

Direction Générale de la Propriété Industrielle

B.P. 269 Bissau  
Tél : (245) 322 22 75  
Fax : (245) 322 34 64 15

(Ministère du Commerce, de l'Industrie et de la Promotion des Produits locaux)

#### GUINEE EQUATORIALE - Malabo

Direction Générale de la Propriété Intellectuelle

B.P. 528 Malabo  
Tél. : (240) 333 09 15 39  
Fax : (240) 333 09 33 13/222 24 43 89

(Consejo de Investigaciones Cientificas y Tecnologicas-CICTE)

#### MALI - Bamako

Centre Malien de Promotion de la Propriété Industrielle (CEMPI)

B.P. 1541 Bamako  
Tél. : (223) 20 28 90 91  
Fax: (223) 20 29 90 91

(Ministère du Commerce et de l'Industrie)

#### MAURITANIE - Nouakchott

Direction du développement Industriel

B.P. 387 Nouakchott  
Tel. : (222) 22 31 21 48/42 43 42 91  
Fax: (222) 525 72 66

(Ministère du Commerce, de l'Industrie, de l'Artisanat et du Tourisme)

#### NIGER - Niamey

Agence Nationale de la Propriété Industrielle et de la Promotion de l'Innovation (ANA2PI)

B.P. 11700 Niamey  
Tél. : (227) 20 75 20 53  
Fax. : (227) 20 73 21 50

(Ministère des Mines et du Développement Industriel)

#### SENEGAL - Dakar

Agence Sénégalaise pour la Propriété Industrielle et l'Innovation Technologique (ASPIIT)

B.P. 4037 Dakar  
Tél. : (221) 33 869 47 70/77 341 79 09  
Fax: (221) 33 827 36 14

(Ministère du Commerce, de l'Industrie et de l'Artisanat)

#### TCHAD - N'djamena

Direction de la Propriété Industrielle et de la Technologie

B.P. 424 N'Djamena  
Tél. : (235) 22 52 08 67  
Fax: (235) 22 52 21 79/68 84 84 18

(Ministère du Commerce et de l'Industrie)

**Sécuriser les investissements étrangers est notre affaire.  
Développer l'Afrique par la propriété intellectuelle est notre vision**

#### TOGO - Lomé

Institut National de la Propriété Industrielle et de la Technologie (INPIT)

B.P. 2339 Lomé Tél. : (228) 22 22 10 08 Fax : (228) 222 44 70

(Ministère du Commerce, de l'Industrie, de la Promotion du secteur privé et du Tourisme)

**PARTIE II :**

**DEMANDES DES DESSINS ET MODELES INDUSTRIELS SELON  
L'ACCORD DE BANGUI, ACTE DE 2015**

(21) **4202400345**

(22) 28/10/2024

(51) 25-01

(54) Profilés de construction

(55)

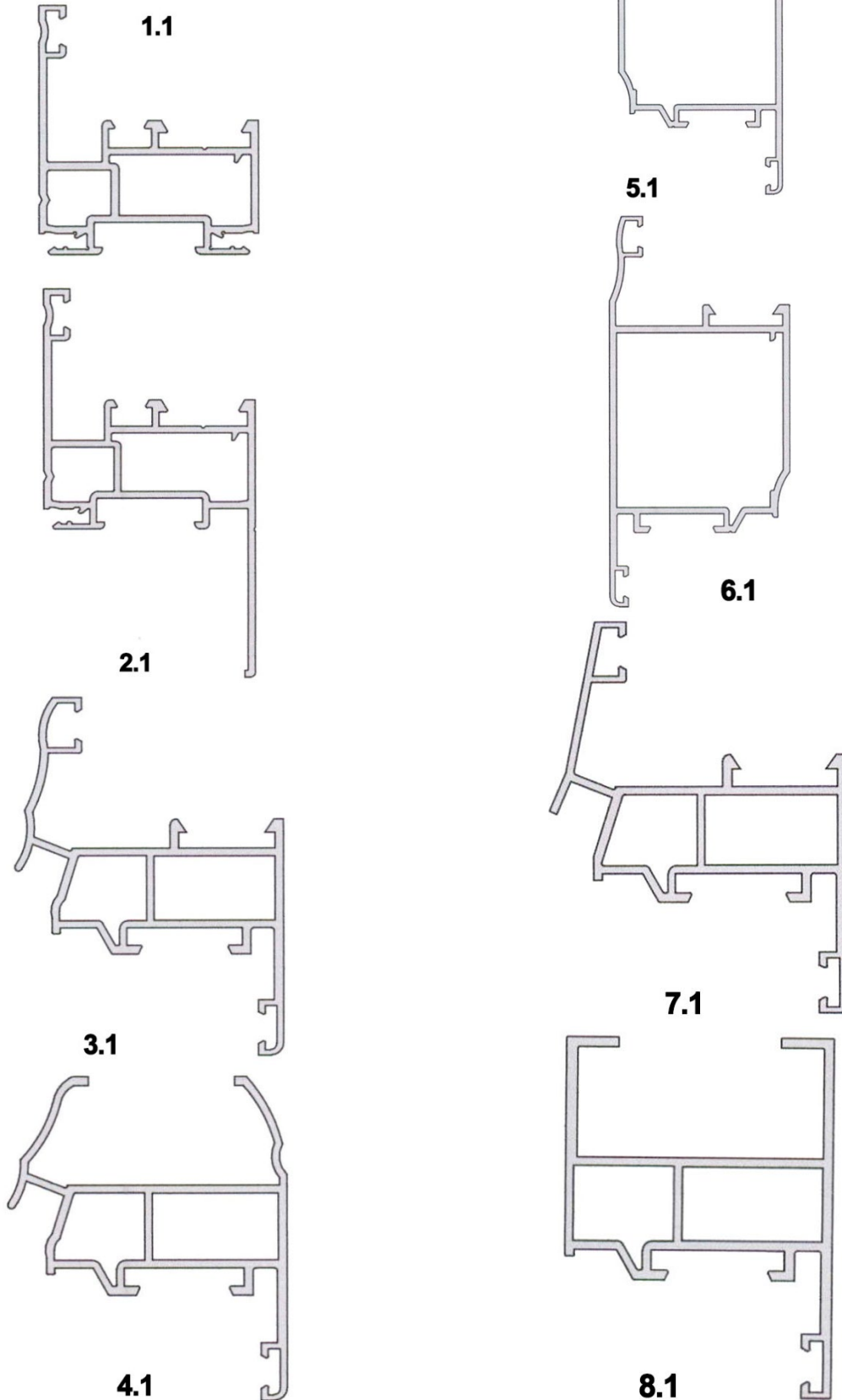

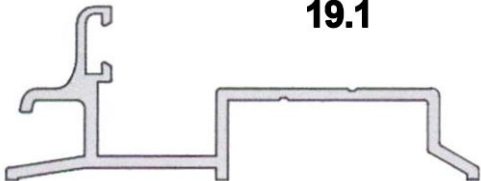
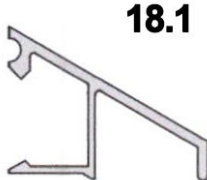
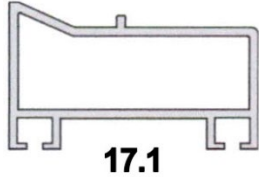
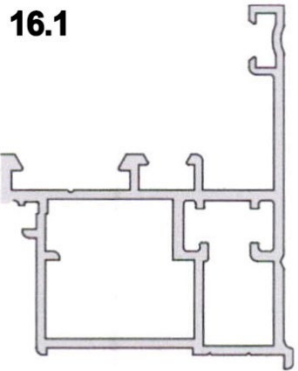
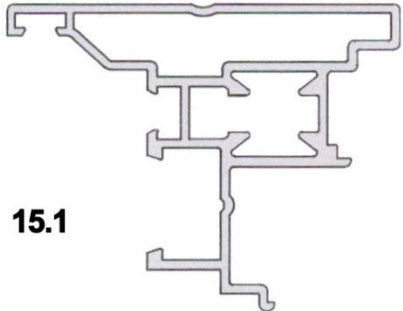
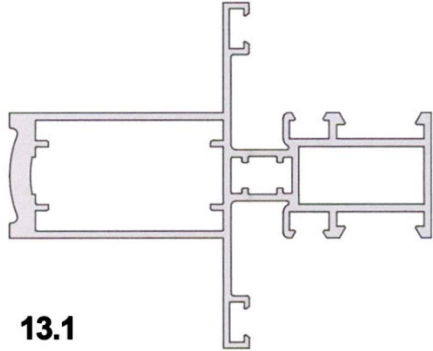
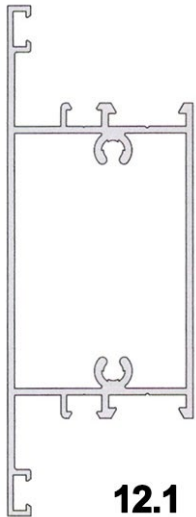
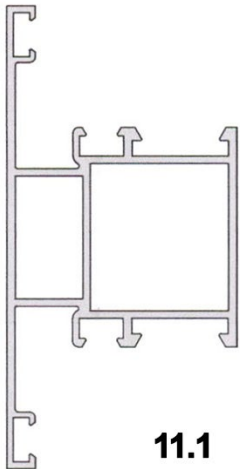
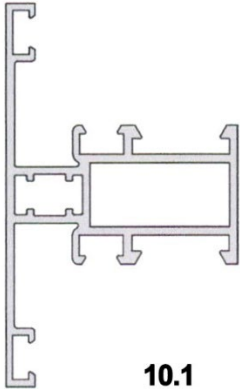
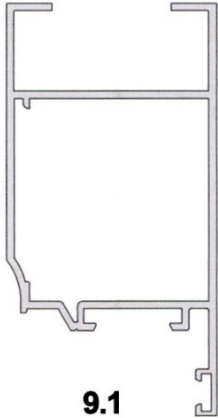

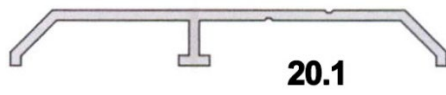

22.1

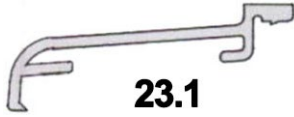

24.1



26.1



27.1

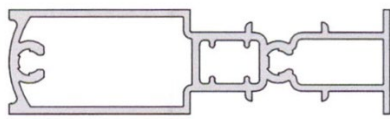

28.1



29.1

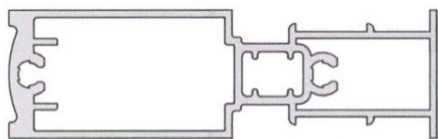

30.1

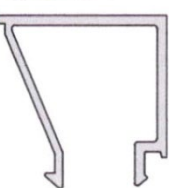

32.1

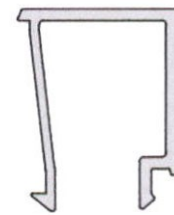
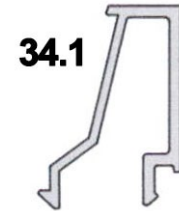
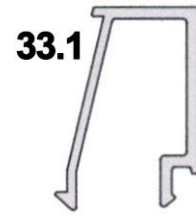

35.1



36.1



37.1



38.1



39.1

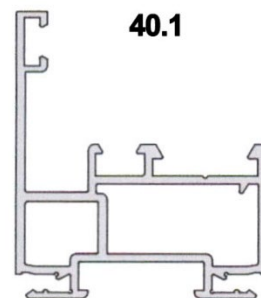

40.1

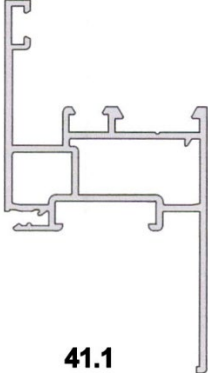

**41.1**

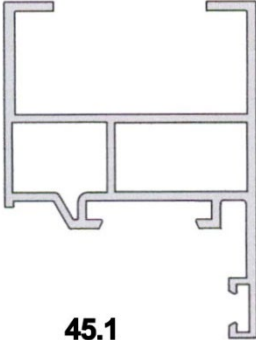

**45.1**

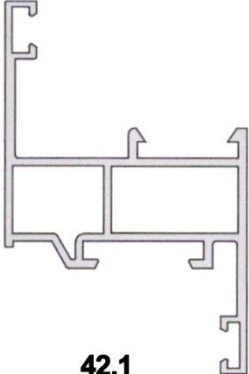

**42.1**

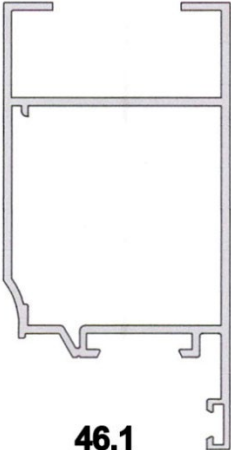

**46.1**

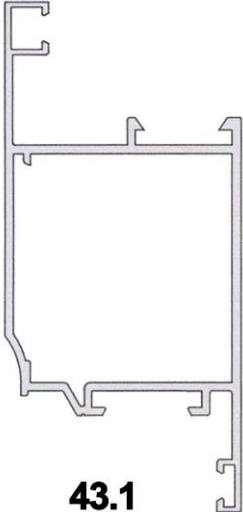

**43.1**

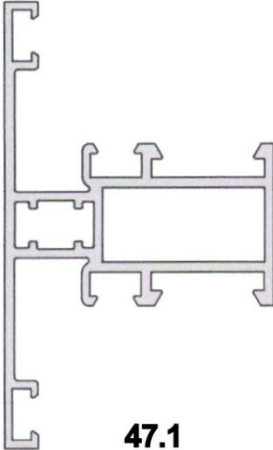

**47.1**

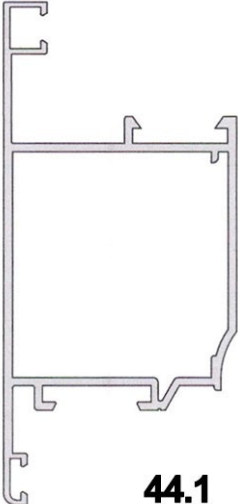

**44.1**

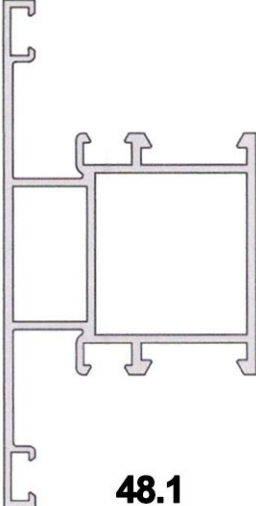

**48.1**

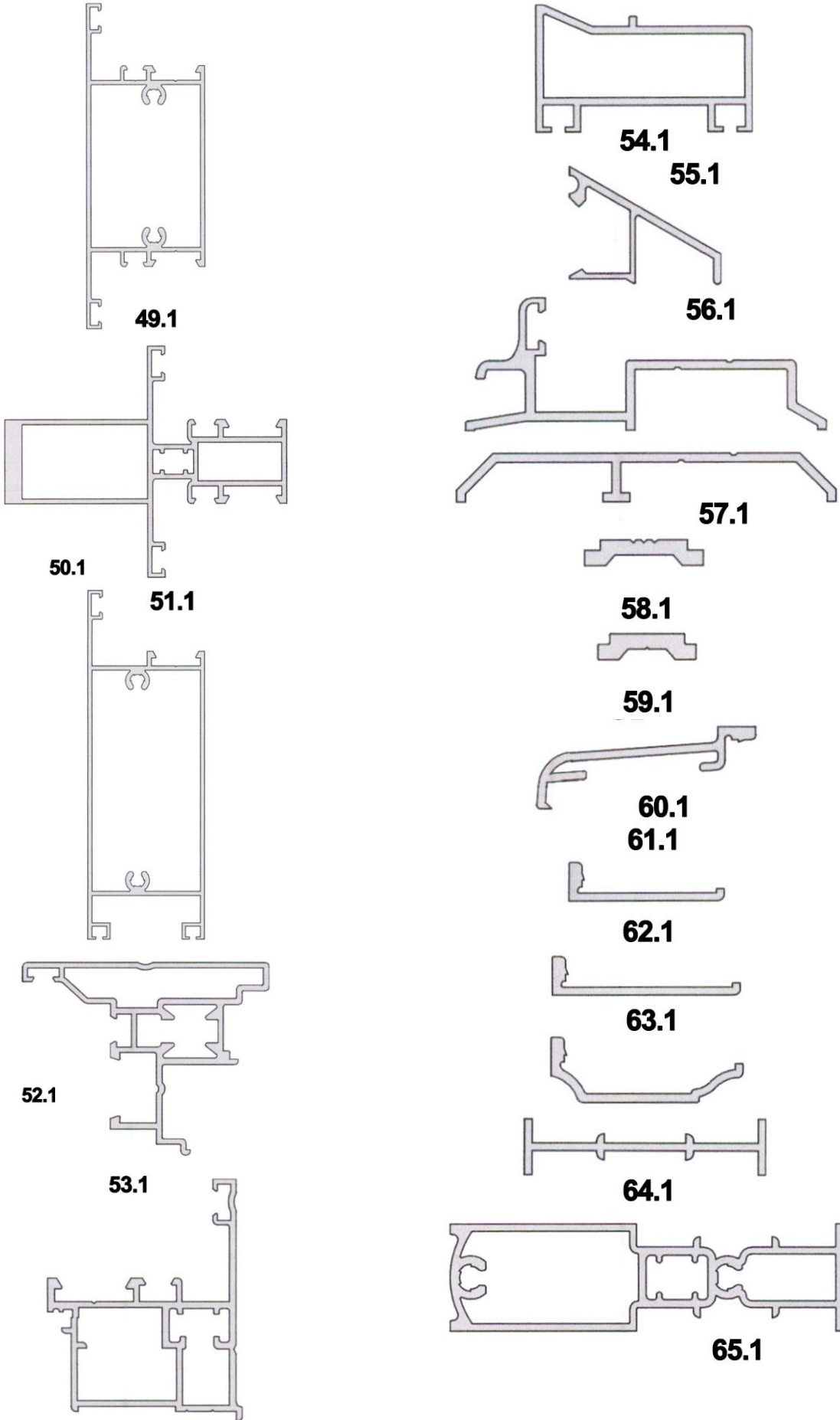

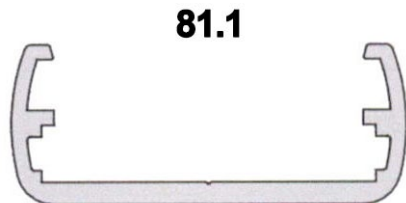
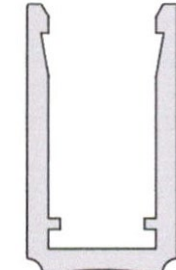
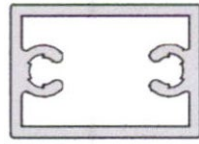
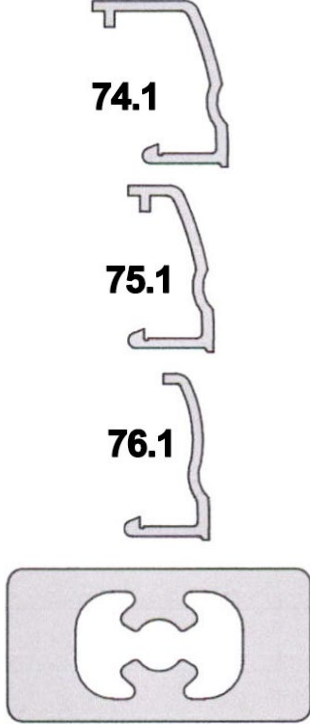
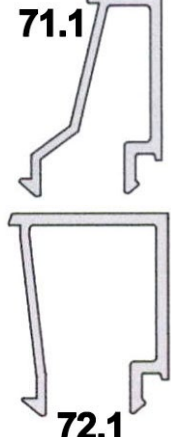
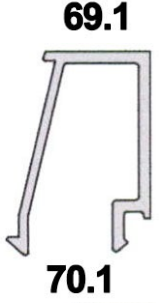
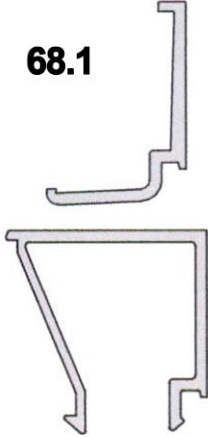
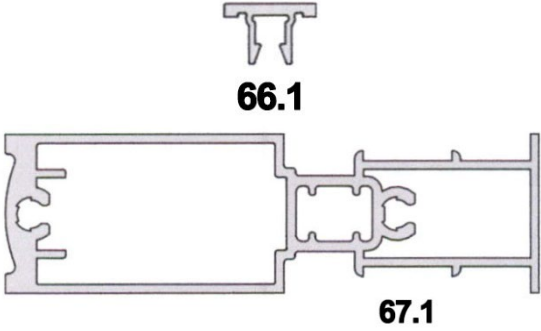

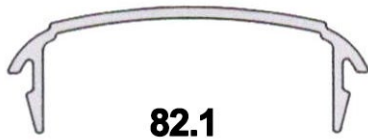

**82.1**



**83.1**



**84.1**



**85.1**

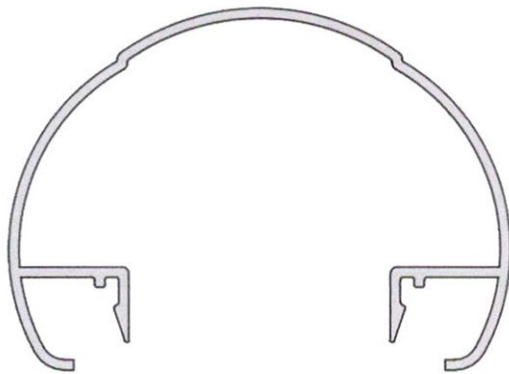

**86.1**

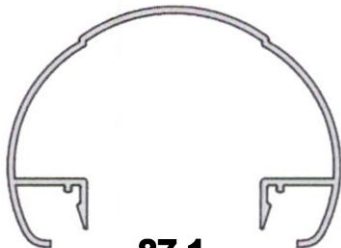

**87.1**

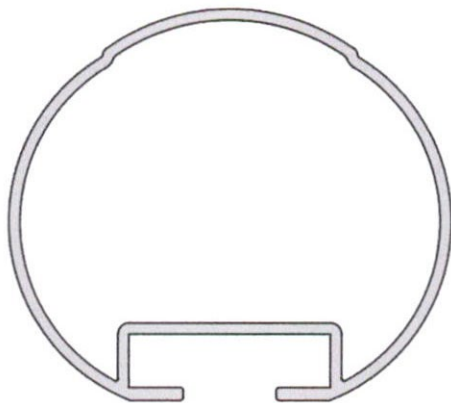

**88.1**

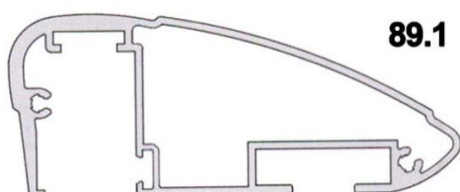

**89.1**

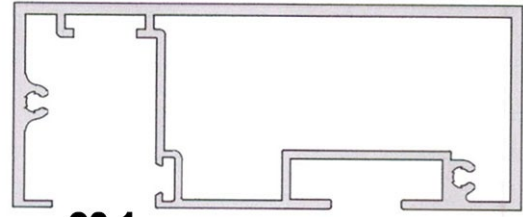

**90.1**

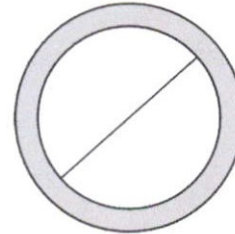

**91.1**



**92.1**

(71) ALUMINIUM DU MAROC S.A, ZONE INDUSTRIELLE; Route de Tetouan, B.P. 324-90000, TANGER (MA)

(74) BYS INGENIERIE, Cocody Riviera Attoban, 01 B.P. 7014, ABIDJAN 01 (CI)

(21) **4202400346**

(22) 13/11/2024

(51) 06-01

(54) Ameublement: chaise

(55)



**1.1**



(71) INDUSTRIE MALIENNE DE FABRICATION DE FER ET DE PLASTIQUE (IMAFPLAST), Zone Industrielle de Dialakorobougou, BAMAKO (ML)

---

(21) **4202400347**

(22) 13/11/2024

(51) 06-01

(54) Ameublement: chaise

(55)



**1.1**



**2.1**



**3.1**

(71) INDUSTRIE MALIENNE DE FABRICATION DE FER ET DE PLASTIQUE (IMAFPLAST), Zone Industrielle de Dialakorobougou, BAMAKO (ML)

---

(21) **4202400348**

(22) 13/11/2024

(51) 06-01

(54) Ameublement: chaise

(55)

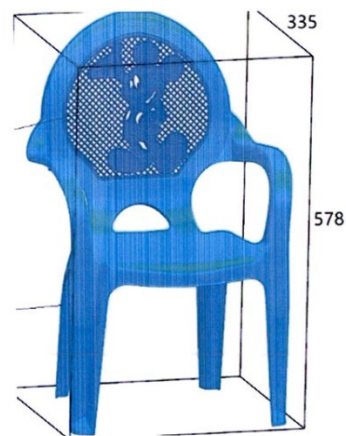

**1.1**

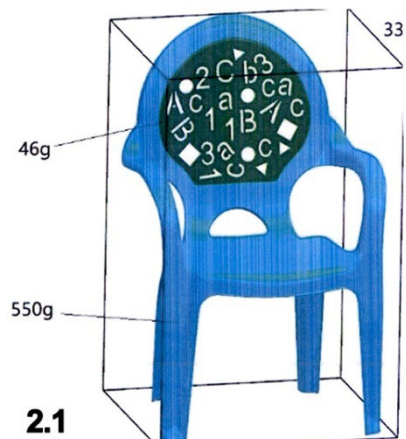

**2.1**

(71) INDUSTRIE MALIENNE DE FABRICATION DE FER ET DE PLASTIQUE (IMAFPLAST), Zone Industrielle de Dialakorobougou, BAMAKO (ML)

---

(21) **4202400349**

(22) 13/11/2024

(51) 06-01

(54) Ameublement: chaise

(55)



(71) INDUSTRIE MALIENNE DE FABRICATION DE FER ET DE PLASTIQUE (IMAFPLAST), Zone Industrielle de Dialakorobougou, BAMAKO (ML)

---

(21) **4202400350**

(22) 13/11/2024

(51) 09-01

(54) Bouteille pour le conditionnement des huiles comestibles

(55)



(71) COSEDI "Compagnie Sénégalaise de Distribution et d'Industrie SUARL", Route du Service Géographique, Hann Equipe, B.P. 27094, DAKAR (SN)

---

(21) **4202400351**

(22) 08/11/2024

(51) 07-01

(54) Ustensile de Vaisselle , ustensile et récipient pour la cuisson, ustensile pour laver, nettoyer ou sécher; autres ustensiles de table; autres récipients de ménage

(55)



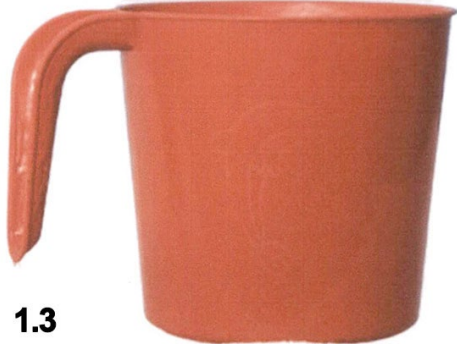

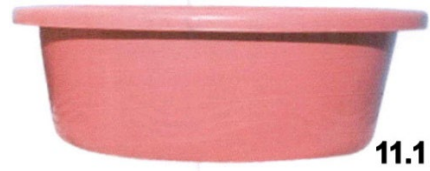



11.4



16.1



12.1



16.2



13.1



17.1



14.1



18.1



15.1

(71) CI PLAST, Yopougon Zone Industrielle,  
21 B.P. 1093, ABIDJAN 21 (CI)

(21) **4202400352**

(22) 06/11/2024

(51) 01-05

(54) Stylo

(55)



**1.1**



**1.2**



**1.3**



**1.4**



**1.5**

(21) **4202400353**

(22) 05/11/2024

(51) 02-04

(54) Chaussure plastique et brique de chaussure

(55)



**1.1**

**1.2**

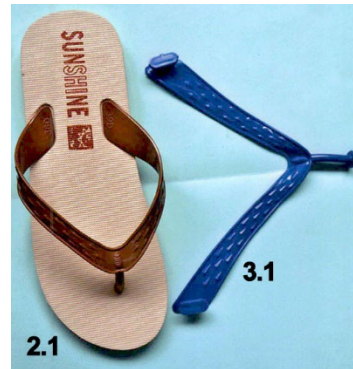

**2.1**

**3.1**

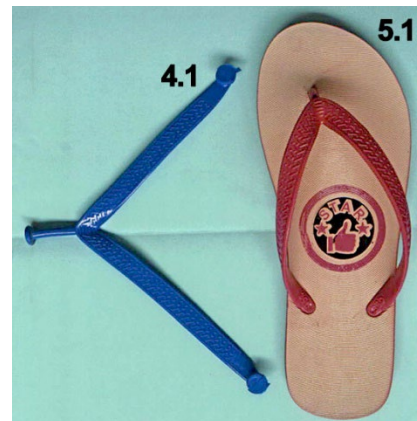

**4.1**

**5.1**



**6.1**

(71) KOKREU GABOU PAUL BORIS,  
COCODY. CITE SYNACASCI II, 01 B.P. 2337,  
ABIDJAN 01 (CI)



(71) TAM CÔTE D'IVOIRE (TAM CI), Zone Industrielle de Koumassi, 10 B.P. 1889, ABIDJAN 10 (CI)

---

(21) **4202400354**

(22) 06/11/2024

(51) 11-03

(54) Macarons lumineux et non lumineux, pins boutonnières

(55)

(71) ALLAH - KOUADIO TIACOH JEAN-CLAUDE, 04 B.P. 151, ABIDJAN 04 (CI)

---

(21) **4202400355**

(22) 06/11/2024

(51) 02-05

(54) Écharpe bandoulière et écharpe de cou

(55)





(71) ALLAH - KOUADIO TIACOH JEAN-CLAUDE, 04 B.P. 151, ABIDJAN 04 (CI)

(21) **4202400356**  
 (22) 14/11/2024  
 (51) 06-03  
 (54) Tabouret en plastique  
 (55)

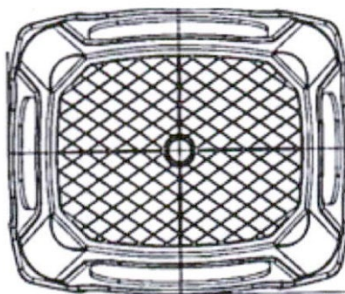
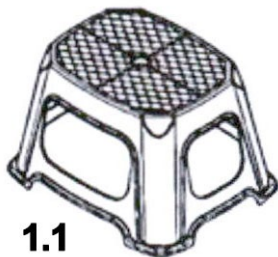

**1.2**

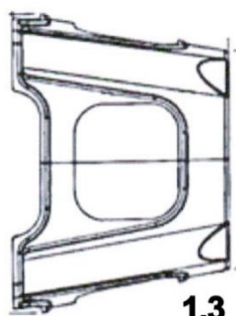

**1.3**

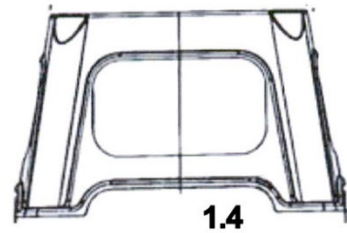

**1.4**

(71) PLAST- KIM, YOPOUGON ZONE INDUSTRIELLE, 05 B.P. 1127, ABIDJAN 05 (CI)

(21) **4202400357**  
 (22) 20/11/2024  
 (51) 19-08  
 (54) Vignette MOST WANTED  
 (55)



**1.1**

(71) QUALITY BEVERAGES SARL, B.P. 7690, Bonabéri, DOUALA (CM)  
 (74) NGAHANE KEGOUM RAYMOND, Déido - Lieu dit 3 boutiques, B.P. 7690, DOUALA (CM)

(21) **4202400358**  
 (22) 20/11/2024  
 (51) 19-08  
 (54) Vignette "MONARCH"  
 (55)

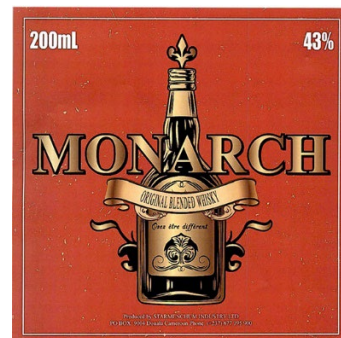

**1.1**

**BOPI 07DM/2026 DEMANDES DE DESSINS ET MODELES INDUSTRIELS SELON L'ACCORD DE BANGUI, ACTE DE 2015**

(71) STAR MENCHUM INDUSTRY LTD,  
Bonaberi, B.P. 9004, DOUALA (CM)

(74) NGAHANE KEGOUM RAYMOND, Déido -  
Lieu dit 3 boutiques, B.P. 7384, DOUALA (CM)

---

(21) **4202400359**

(22) 25/11/2024

(51) 06-10

(54) Moustiquaire

(55)



**1.1**

(71) MOUASSOM TOUKO Cyrille, B.P. 1023,  
YAOUNDE (CM)

---

(21) **4202400360**

(22) 15/11/2024

(51) 12-11

(54) CYCLES ET MOTOCYCLES

(55)



**1.1**

**1.2**

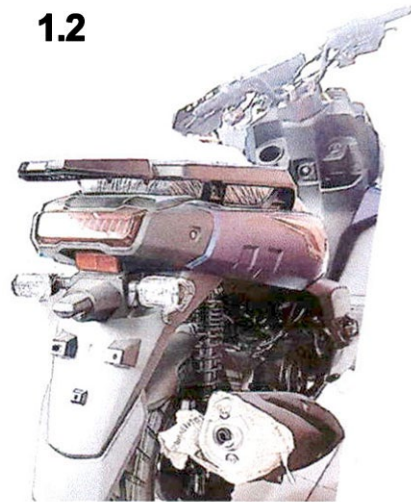

**1.3**

**1.4**



(71) Établissements MEKANES, Quartier  
Kaporo-Commune de Ratoma, 5556 Conakry  
(GN)

(74) CABINET FAOULY BANGOURA &  
COMPAGNIE, Immeuble Taouyah, carrefour  
du grand marché de Taouyah, près de la  
Mairie de Ratoma, B.P. 5556, CONAKRY  
Guinée (GN)

---

(21) **4202400363**

(22) 12/11/2024

**BOPI 07DM/2026 DEMANDES DE DESSINS ET MODELES INDUSTRIELS SELON L'ACCORD DE BANGUI,  
ACTE DE 2015**

(51) 05-06

(54) ARTICLES TEXTILES NON  
CONFECTIONNES, FEUILLE DE MATIERE  
ARTIFICIELLE OU NATURELLE.

(55)



**1.1**

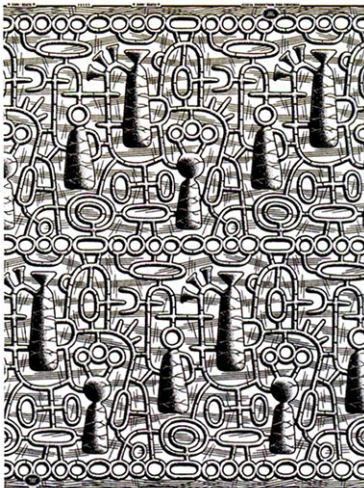

**2.1**

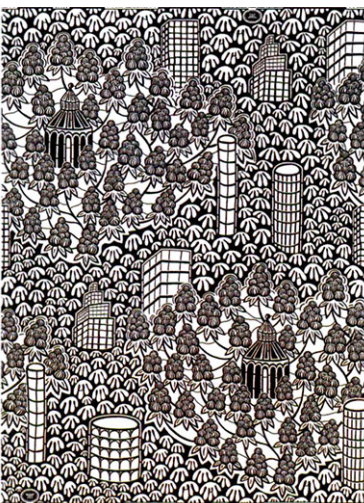

**3.1**

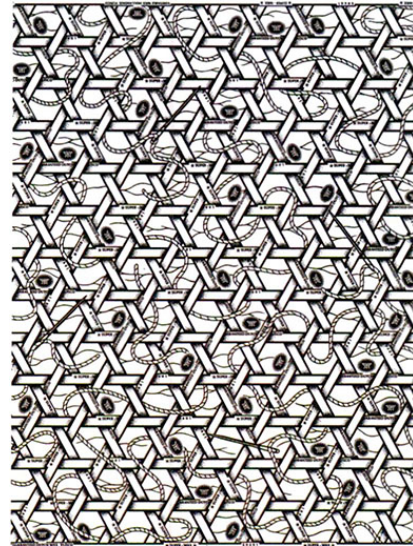

**4.1**



**5.1**



**6.1**

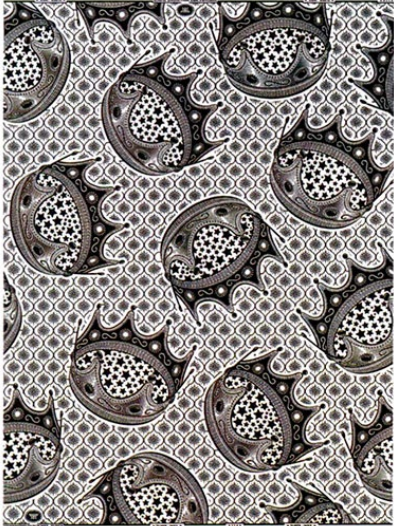

**7.1**



**10.1**

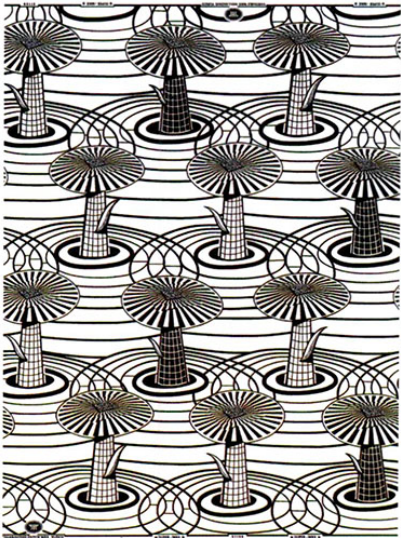

**8.1**

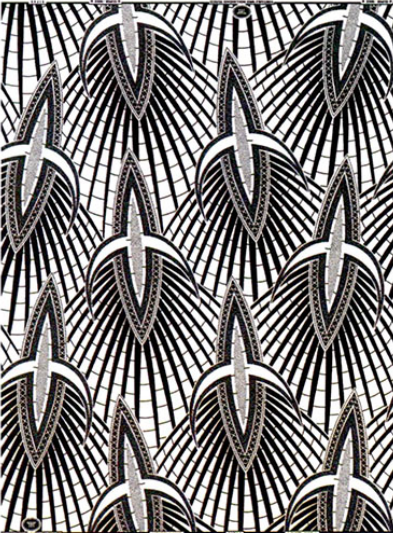

**11.1**



**9.1**



**12.1**



**13.1**



**16.1**

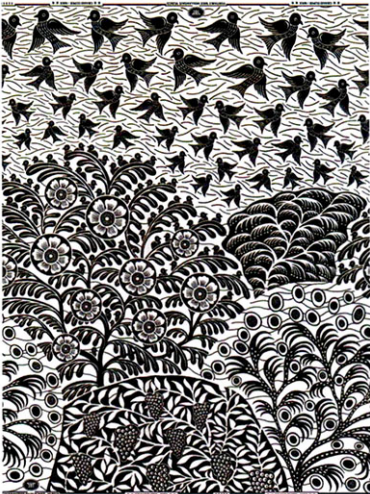

**14.1**

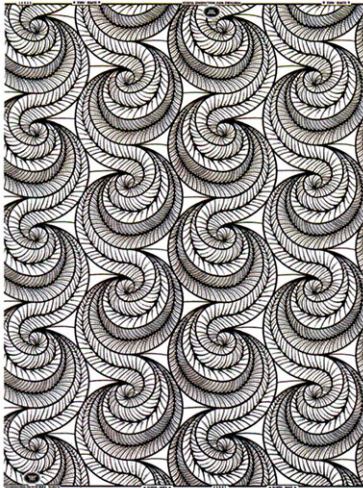

**17.1**



**15.1**



**18.1**

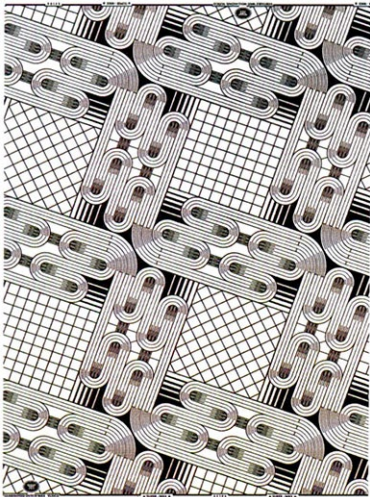

**19.1**



**22.1**

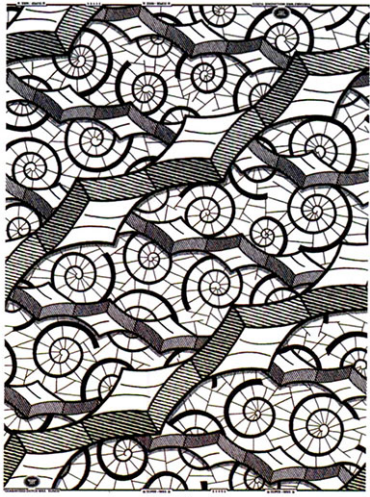

**20.1**



**23.1**



**21.1**

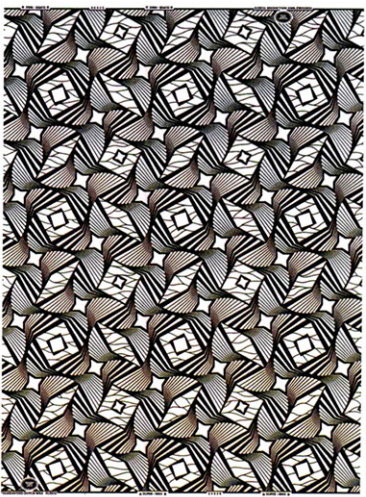

**24.1**

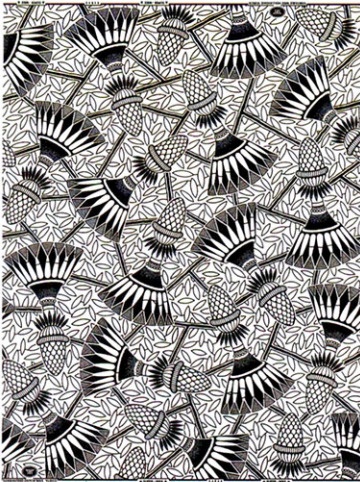

**25.1**

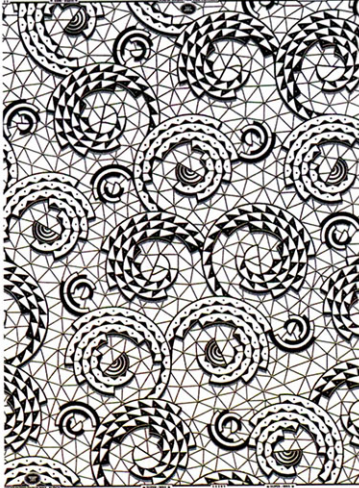

**28.1**

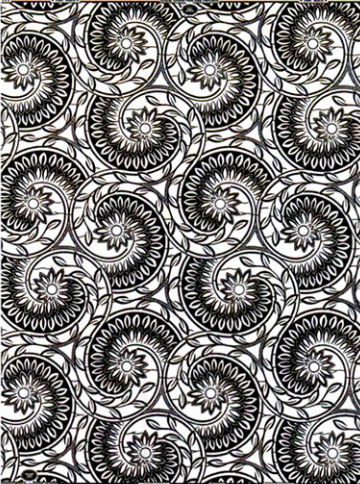

**26.1**

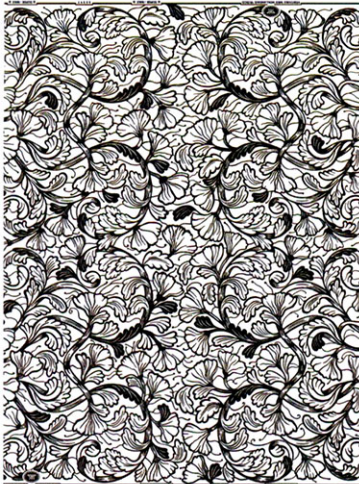

**29.1**



**27.1**

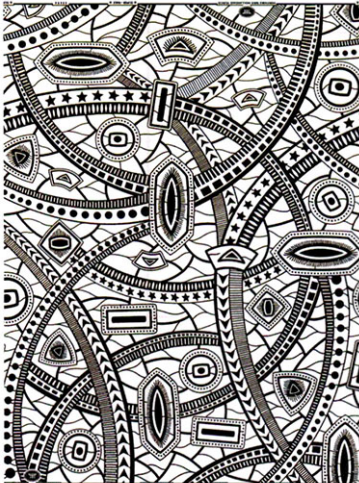

**30.1**



**31.1**

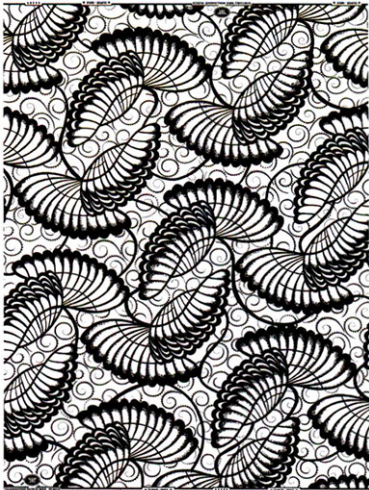

**34.1**



**32.1**

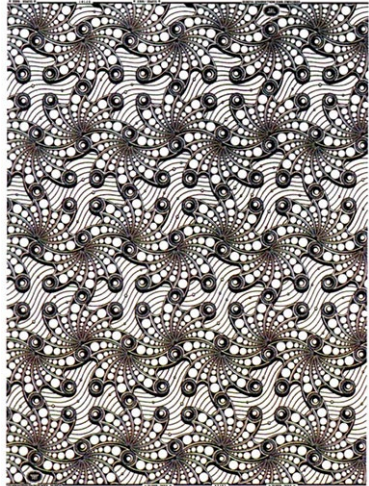

**35.1**

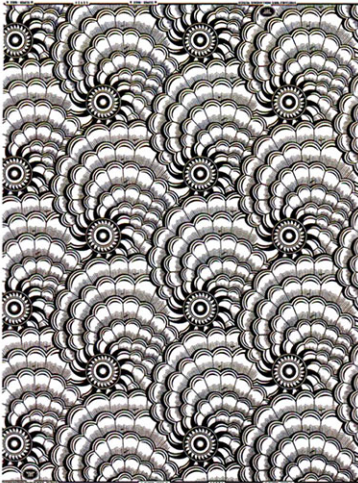

**33.1**



**36.1**



**37.1**



**40.1**

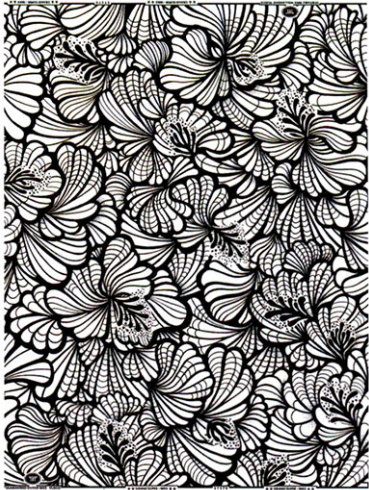

**38.1**



**41.1**



**39.1**



**42.1**

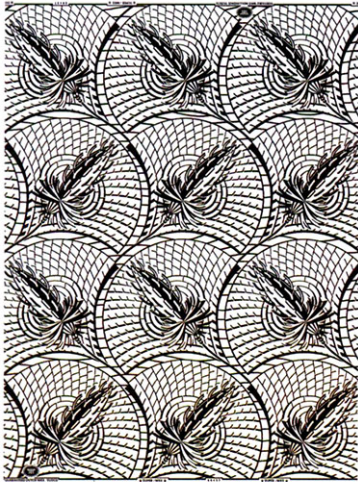

**43.1**



**46.1**

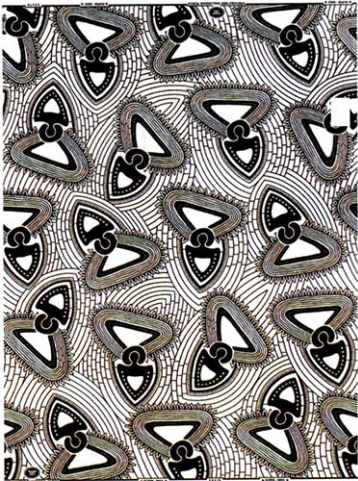

**44.1**

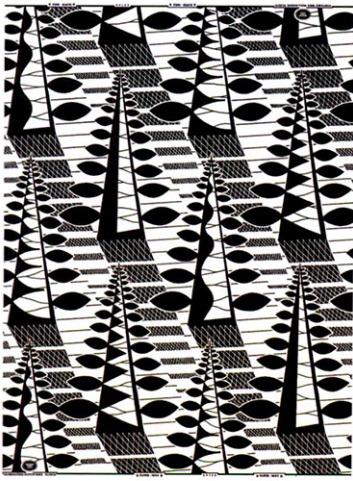

**47.1**



**45.1**



**48.1**



**49.1**



**52.1**

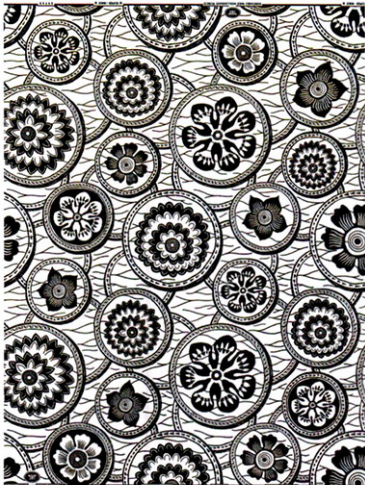

**50.1**

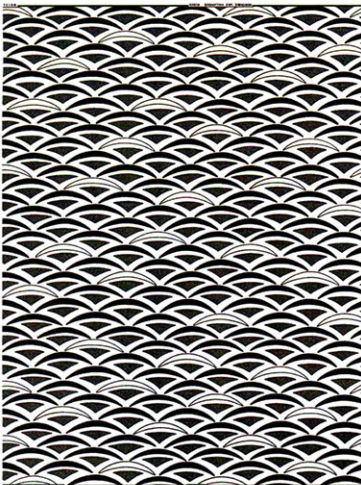

**53.1**

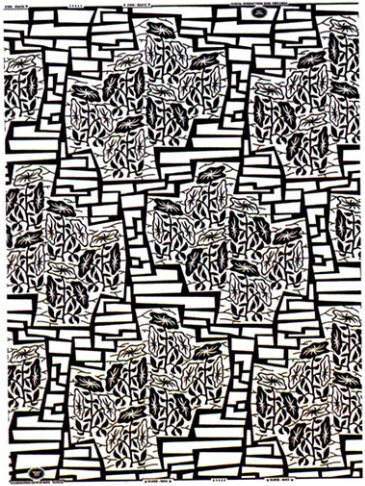

**51.1**



**54.1**

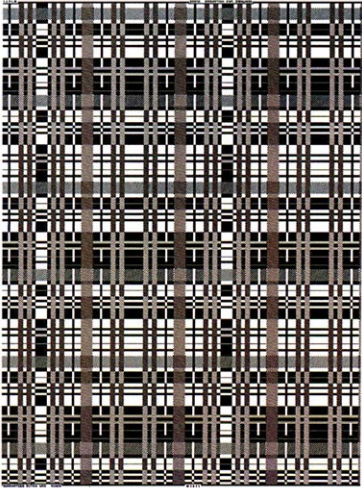

**55.1**

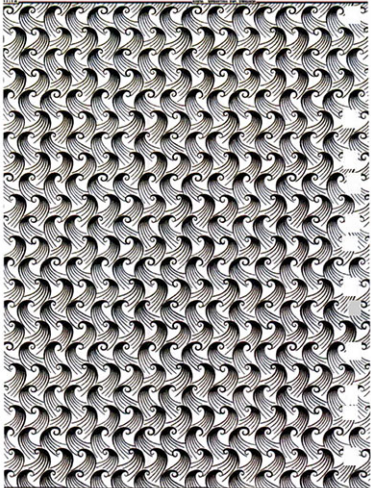

**58.1**

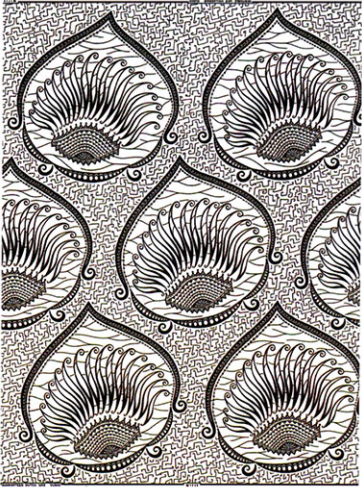

**56.1**

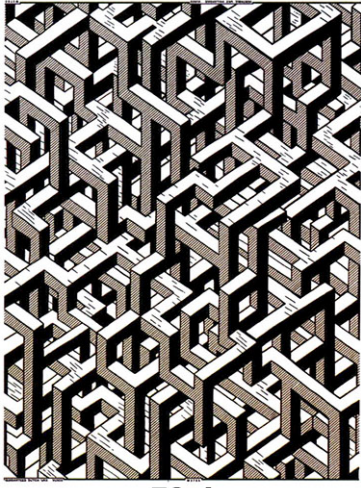

**59.1**



**57.1**



**60.1**



**61.1**

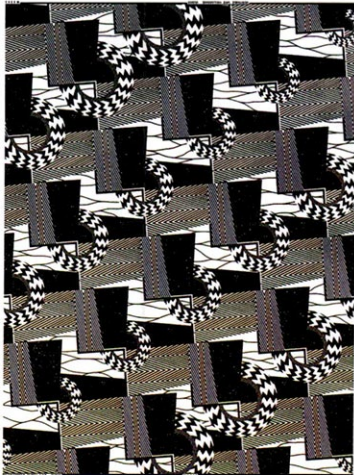

**64.1**

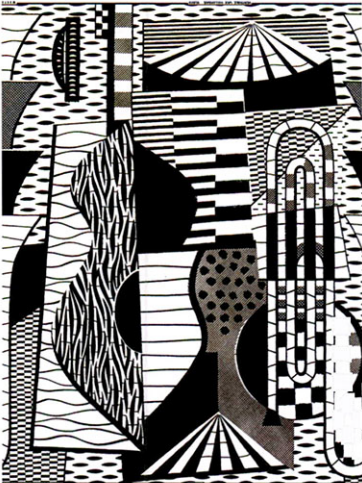

**62.1**

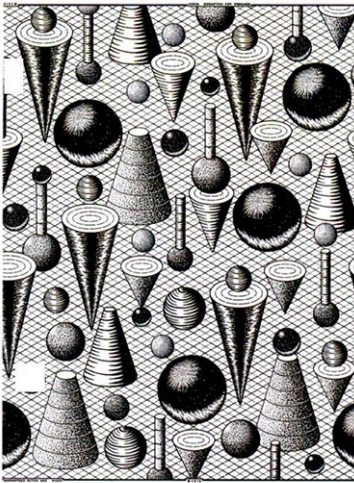

**65.1**

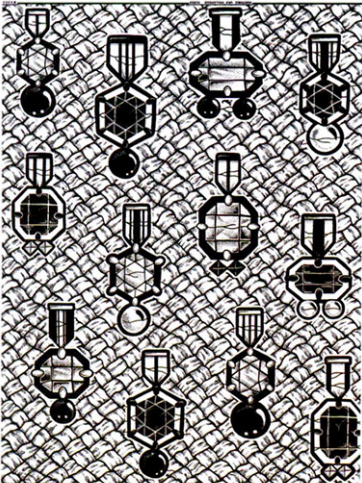

**63.1**

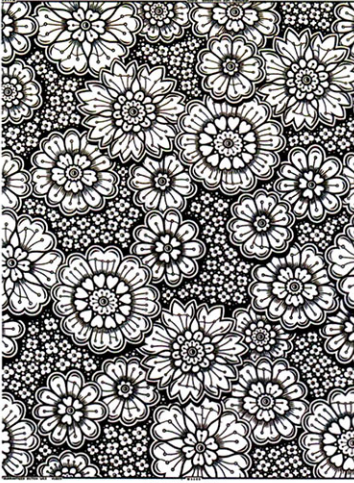

**66.1**



**67.1**

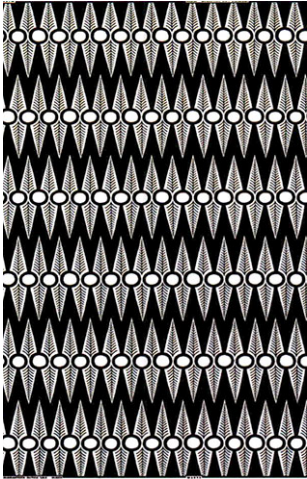

**70.1**

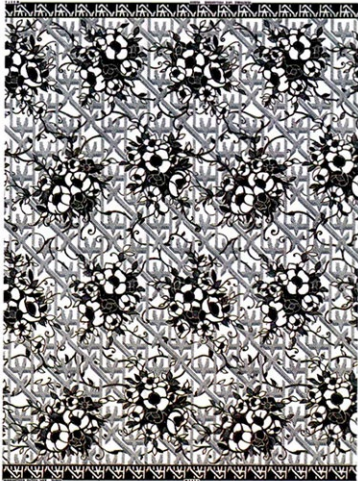

**68.1**



**71.1**

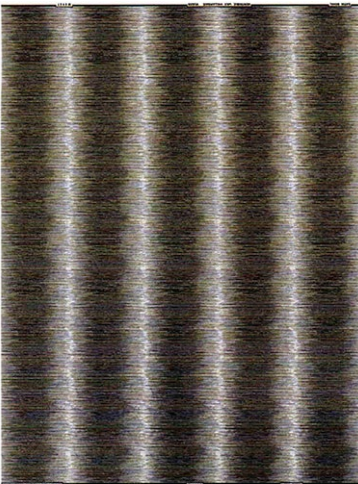

**69.1**



**72.1**

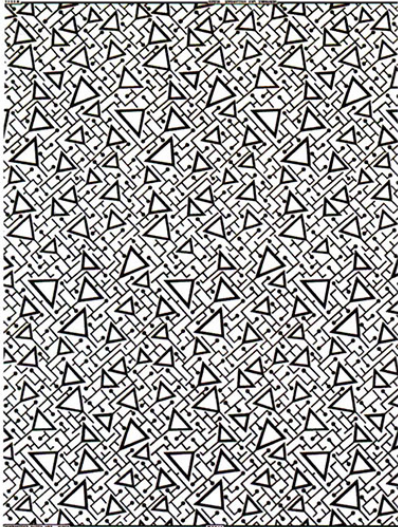

73.1

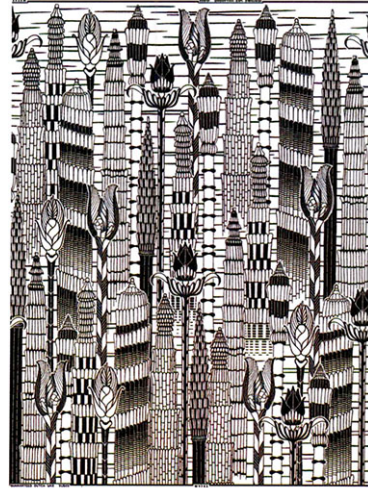

76.1

(71) UNIWAX, Abidjan Yopougon Zone Industrielle, 01 B.P. 3994, ABIDJAN 01 (CI)



74.1

(21) **4202400364**

(22) 26/08/2024

(51) 09-01

(54) Emballages de produits alimentaires:  
Carton, bouteille et sac de riz Dragon

(55)



1.1

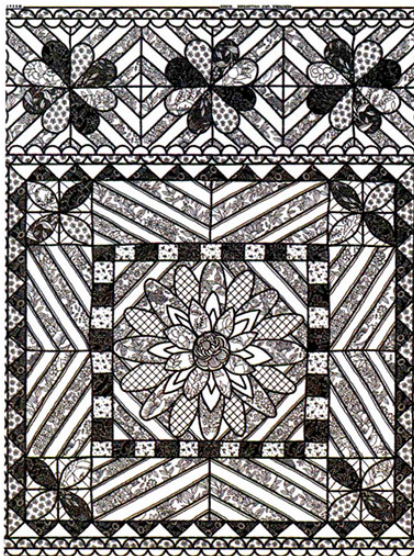

75.1



2.1



**3.1**

(71) LI WENJIAN, Point-E Résidence Lili, DAKAR (SN)

(21) **4202400366**

(22) 28/11/2024

(51) 15-01

(54) MOTEUR

(55)

(71) LI WENJIAN, Km 18, Route de Rufisque, DAKAR (SN)

(21) **4202400365**

(22) 30/07/2024

(51) 02-02

(54) Couches Chanceux Bébé

(55)



**1.1**

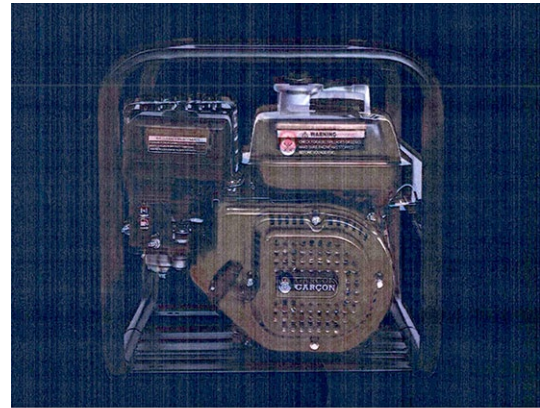

**1.1**



**2.1**



**2.1**



**3.1**

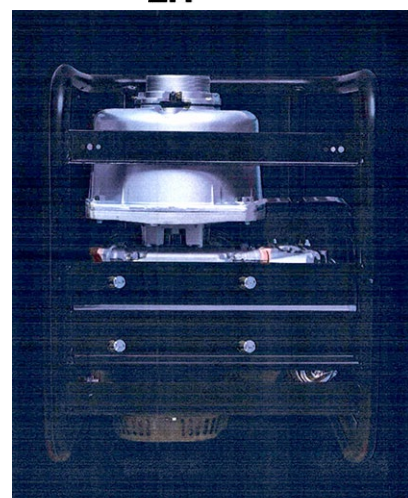

**3.1**

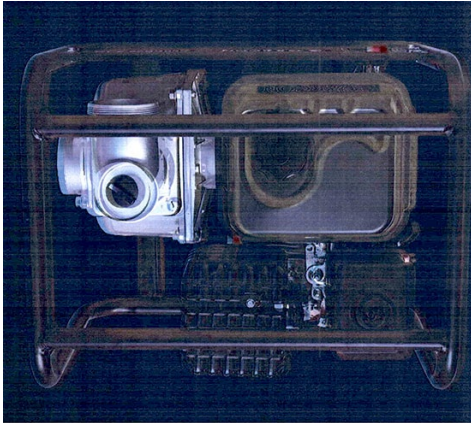

**4.1**



**5.1**

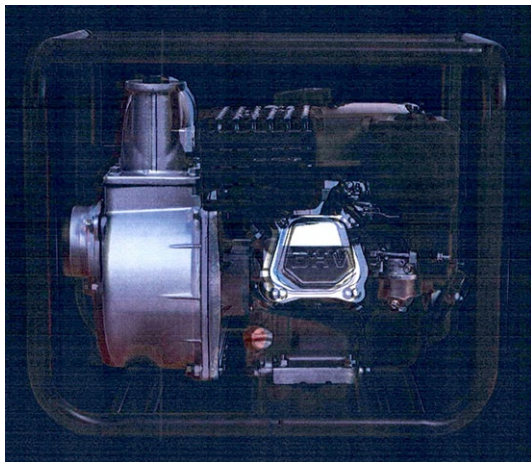

**6.1**

(71) Ets GAOUSSOU TRAORE, Immeuble Simpara Center Boutique N°49 Dabanani, BAMAKO (ML)

(21) **4202400372**

(22) 29/11/2024

(51) 06-02

(54) Chaise et table

(55)



**1.1**

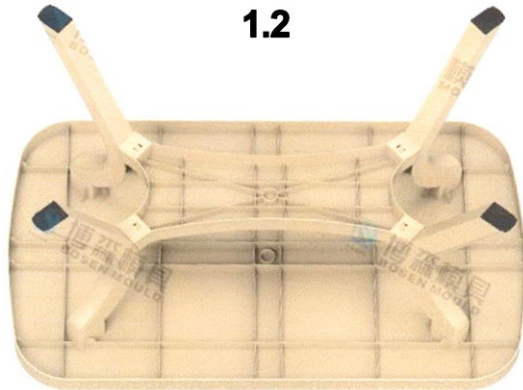

**1.2**

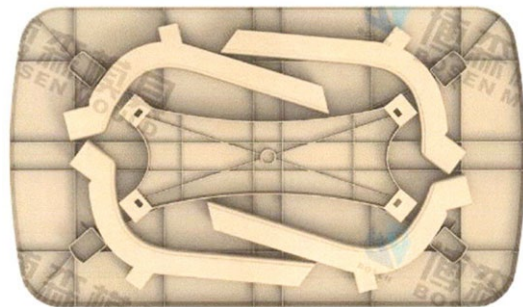

**1.3**



**2.1**

**2.2**



**3.1**



**3.2**

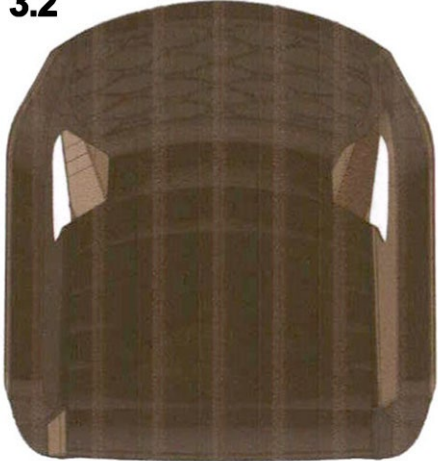

**2.3**



**2.4**



**3.3**



**3.4**



(71) OK PLAST, Yopougon, Zone Industrielle,  
23 B.P. 932, ABIDJAN 23 (CI)

---

(21) **4202400373**

(22) 22/11/2024

(51) 02-02

(54) ARTICLES D'HABILLEMENT : SAC,  
BLOUSE ET TABLIER

(55)



**1.1**



**1.2**



**2.1**



**3.1**



**4.1**



**4.2**

**BOPI 07DM/2026 DEMANDES DE DESSINS ET MODELES INDUSTRIELS SELON L'ACCORD DE BANGUI,  
ACTE DE 2015**

(71) GRAFICA IVOIRE, Treichville Zone 3, 18  
B.P. 303, ABIDJAN 18 (CI)

---

(21) **4202400374**

(22) 27/11/2024

(51) 09-01

(54) FLACONS

(55)



**1.1**



**2.1**



**3.1**



**4.1**

(71) SIDIS, Zone Industrielle Yopougon, 21  
B.P. 2656, ABIDJAN 21 (CI)

---

(21) **4202400375**

(22) 26/11/2024

(51) 06-01

(54) Chaise en plastique

(55)



**1.1**



**2.1**



**3.1**

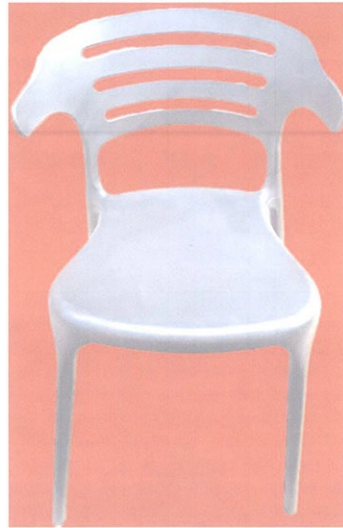

**6.1**



**4.1**



**7.1**



**5.1**



**8.1**



(71) ZHUANG XIAODU, Adjame Derrière Mairie, 01 B.P. 2337, ABIDJAN 01 (CI)

---



(21) **4202400376**

(22) 27/11/2024

(51) 06-03

(54) TABLE-BANC

(55)





**1.4**



**2.1**



**2.2**

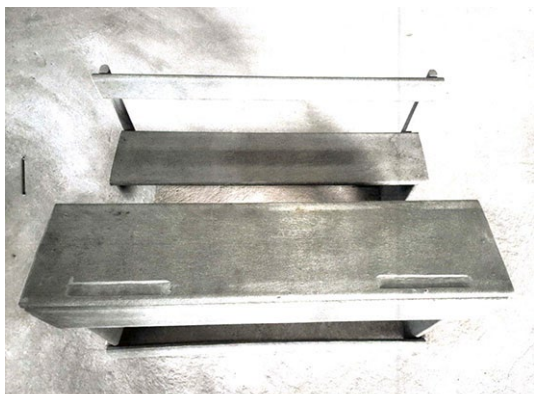

**2.3**



**2.4**

(71) YAO DJE HERMANN STEPHANE, 01 B.P. 2337, ABIDJAN 01 (CI)

(74) CABINET S-OUATTARA ET ASSOCIES, Abidjan-Cocody, 04 B.P. 382, ABIDJAN 04 (CI)

(21) **4202400377**

(22) 26/11/2024

(51) 13-02

(54) Borne de recharge pour véhicule électrique

(55)



**1.1**



**1.2**



**1.3**



**1.3**

(71) ARNIO, PLATEAU IMMEUBLE LA DREN  
5ème ETAGE, 01 B.P. 7696, ABIDJAN 01 (CI)

---

(21) **4202400378**

(22) 21/11/2024

(51) 02-04

(54) Chaussure plastique

(55)



**2.1**



**1.1**



**1.2**



**3.1**



3.2



3.3



4.1

(21) 4202400379

(22) 27/11/2024

(51) 05-05

(54) TISSUS ET ÉTOFFES

(55)

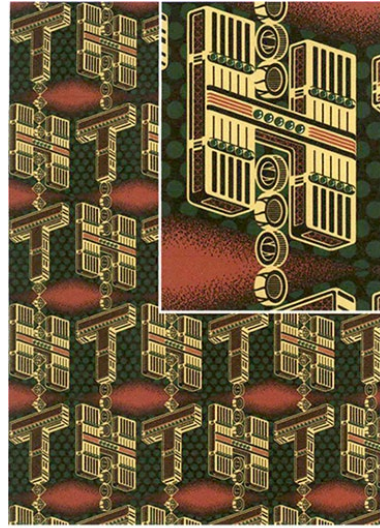

1.1



2.1

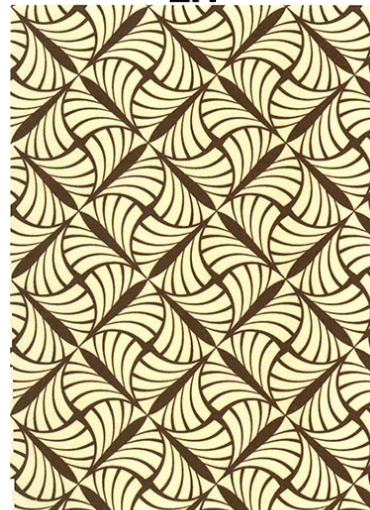

3.1

(71) ETS CHEF PLAST, Zone Industrielle  
Koumassi, 01 B.P. 1860, ABIDJAN 01 (CI)

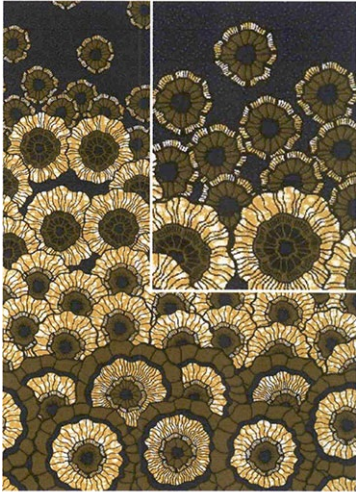

**4.1**



**7.1**



**5.1**



**8.1**

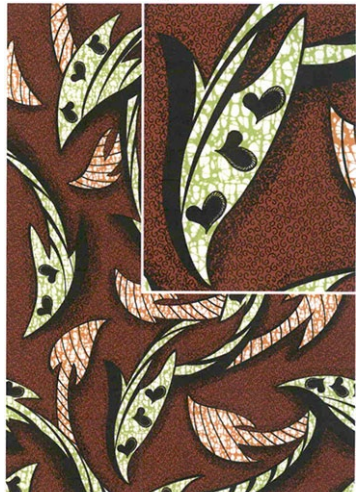

**6.1**



**9.1**

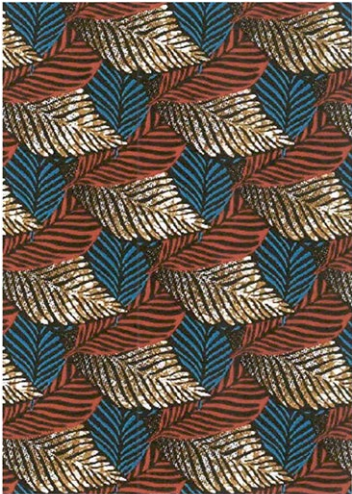

**10.1**



**13.1**

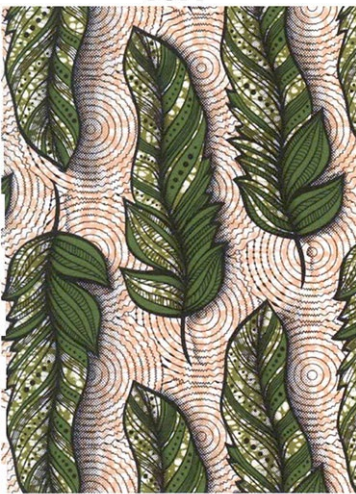

**11.1**



**14.1**

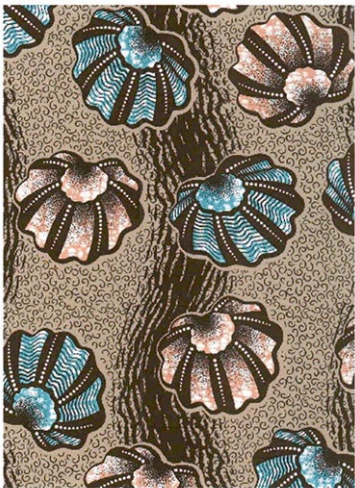

**12.1**

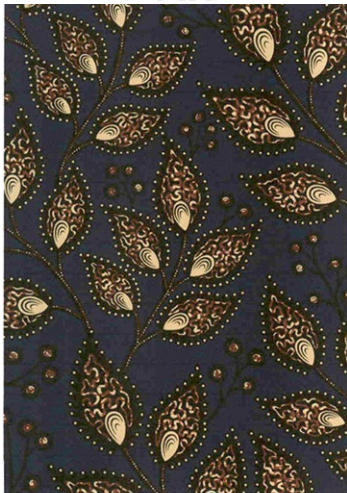

**15.1**



**16.1**



**19.1**



**17.1**

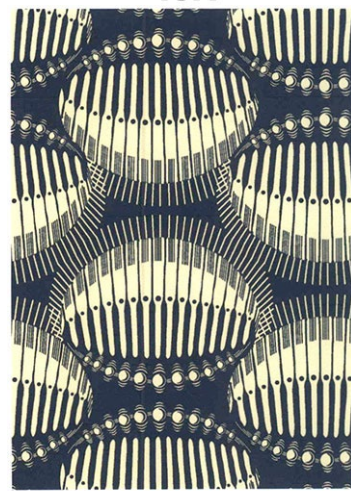

**20.1**

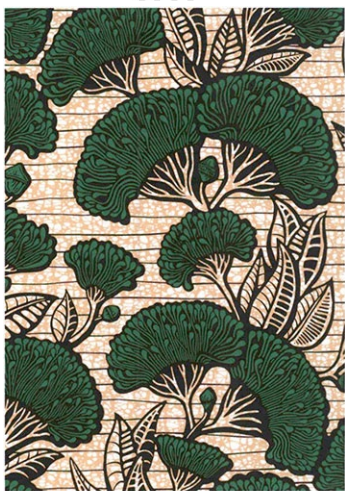

**18.1**

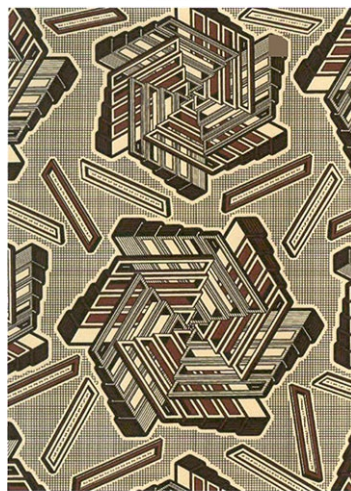

**21.1**



**22.1**



**25.1**

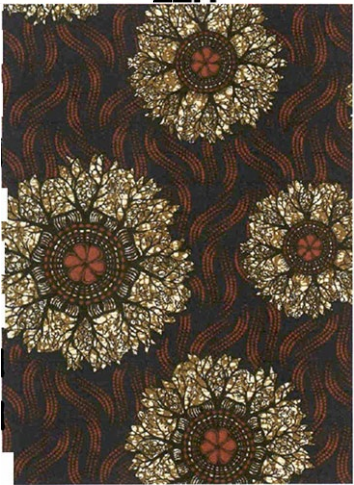

**23.1**



**26.1**



**24.1**

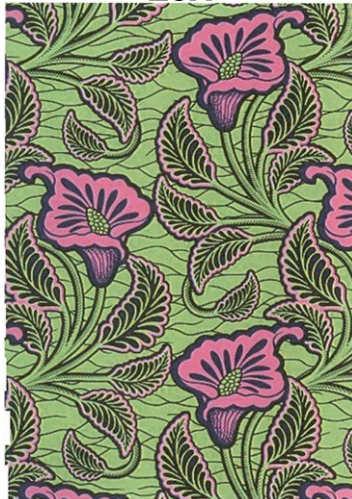

**27.1**

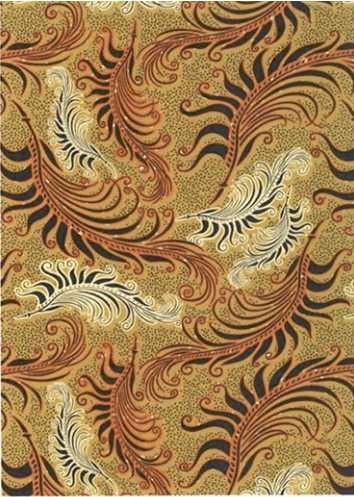

**28.1**



**31.1**



**29.1**

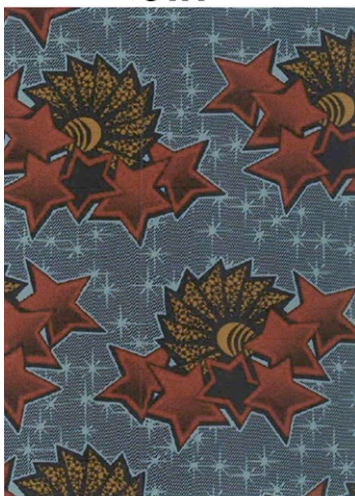

**32.1**

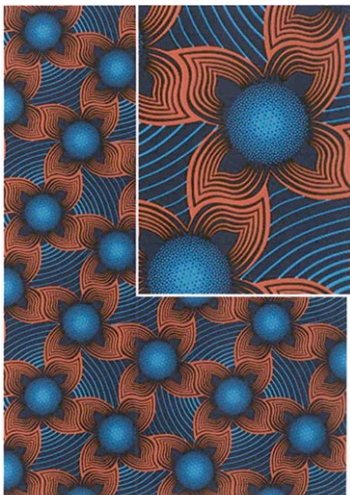

**30.1**



**33.1**



**34.1**

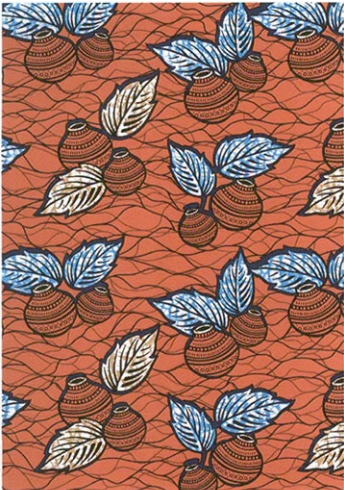

**37.1**



**35.1**

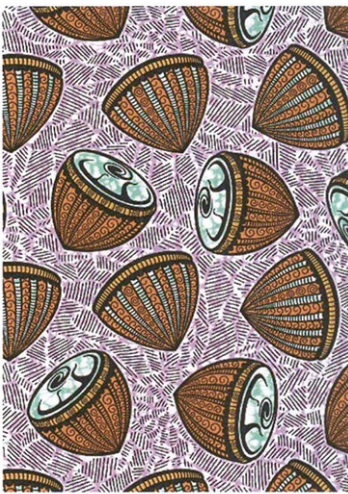

**38.1**

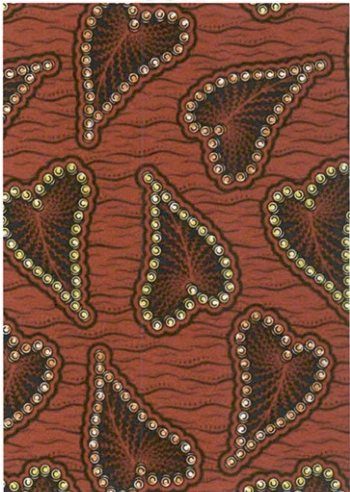

**36.1**

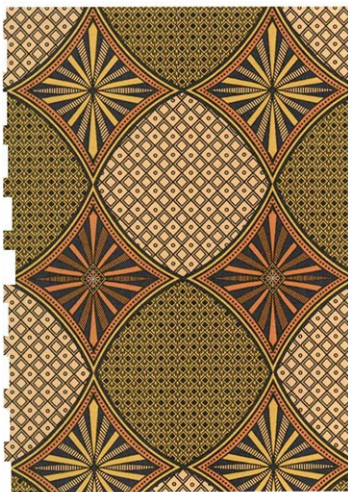

**39.1**

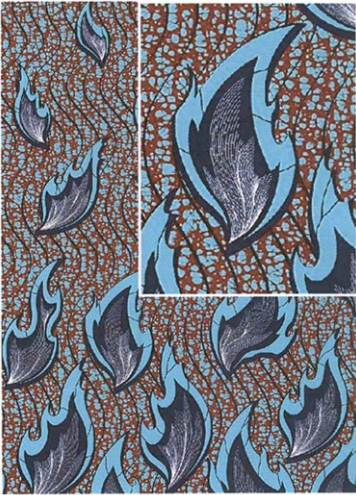

**40.1**

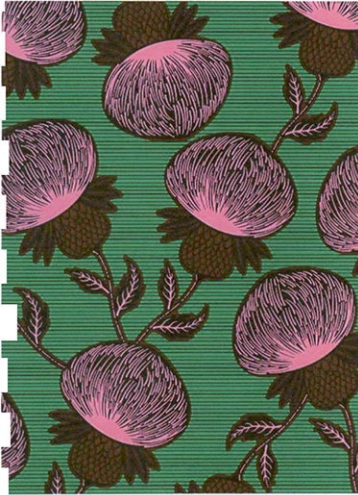

**43.1**

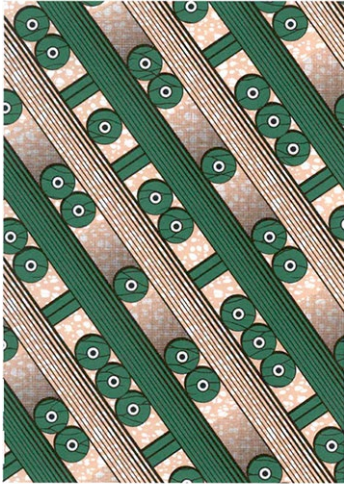

**41.1**



**44.1**

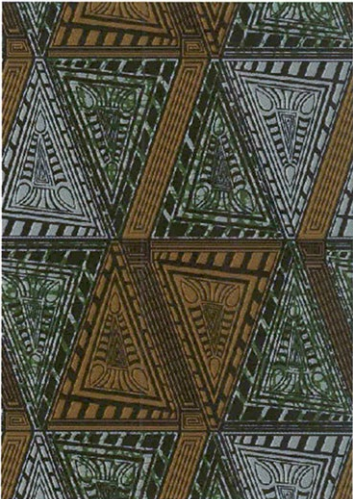

**42.1**

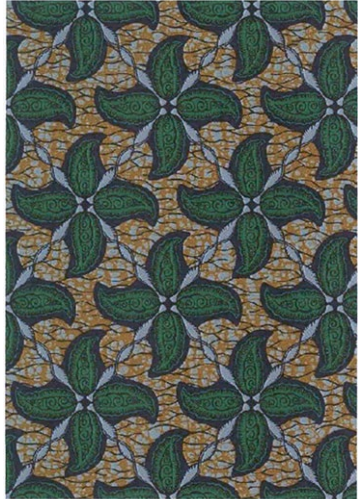

**45.1**

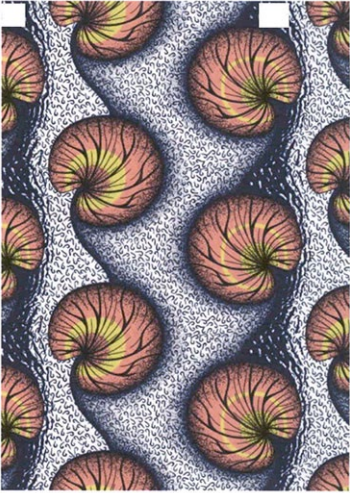

**46.1**

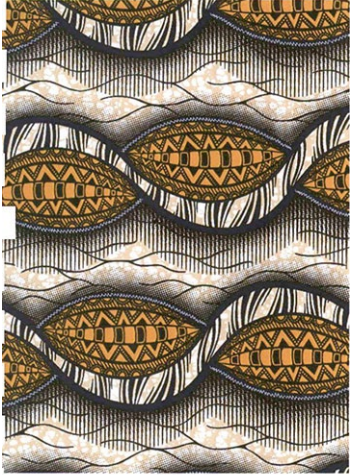

**49.1**

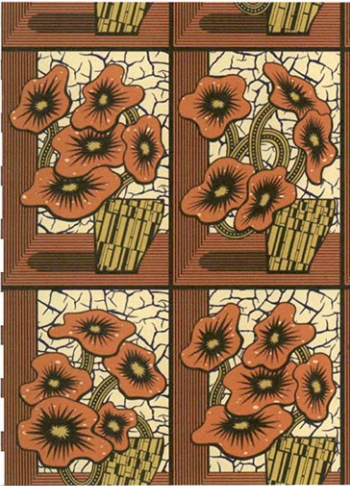

**47.1**



**50.1**



**48.1**



**51.1**

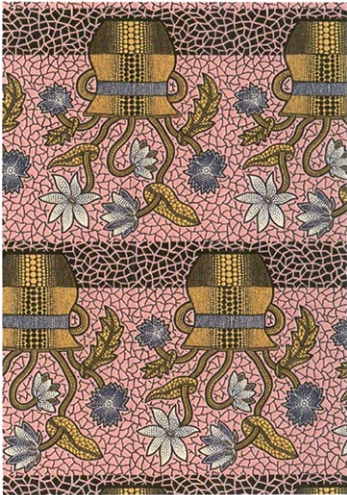

**52.1**



**55.1**



**53.1**



**56.1**



**54.1**

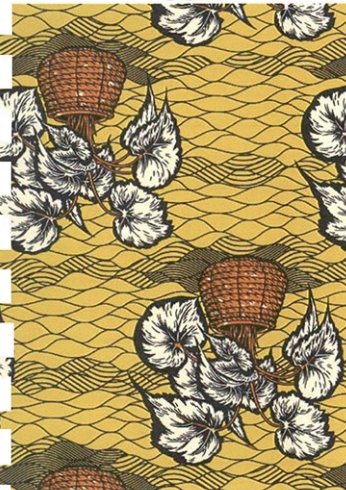

**57.1**

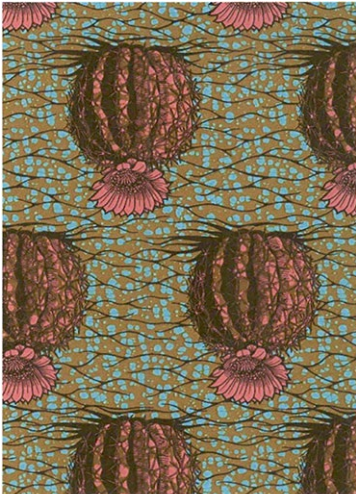

**58.1**

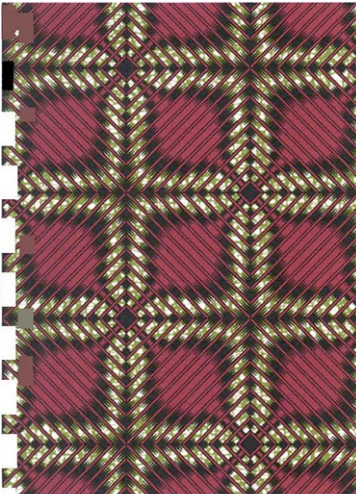

**61.1**

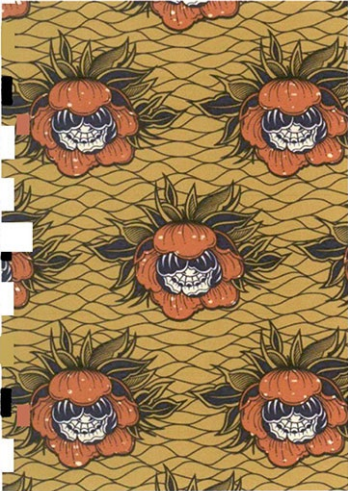

**59.1**

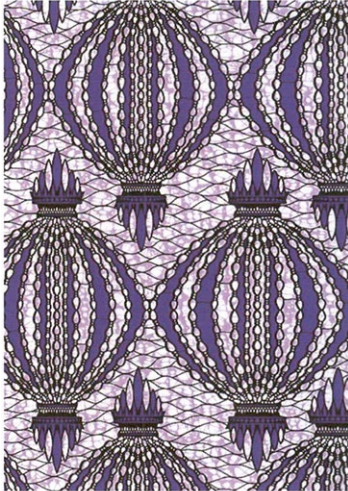

**62.1**

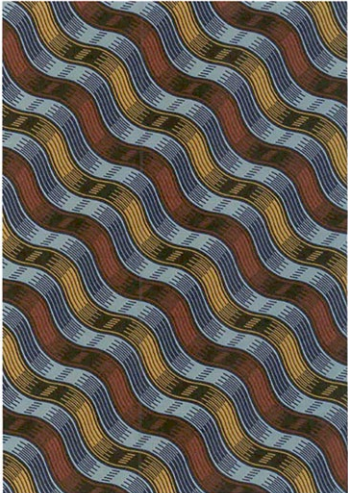

**60.1**



**63.1**



**64.1**

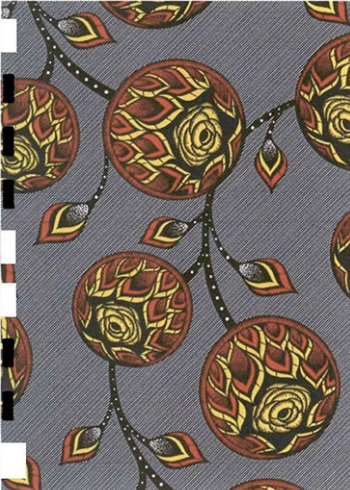

**67.1**



**65.1**

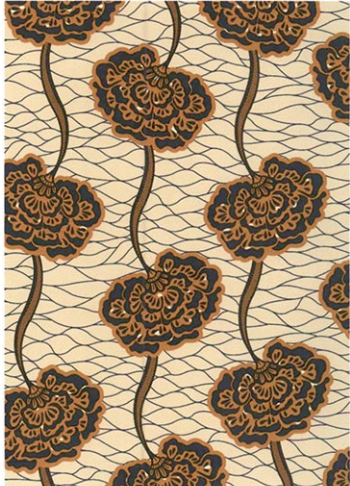

**68.1**



**66.1**



**69.1**

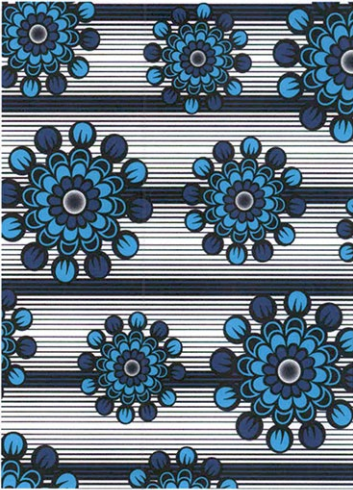

**70.1**



**73.1**



**71.1**



**74.1**

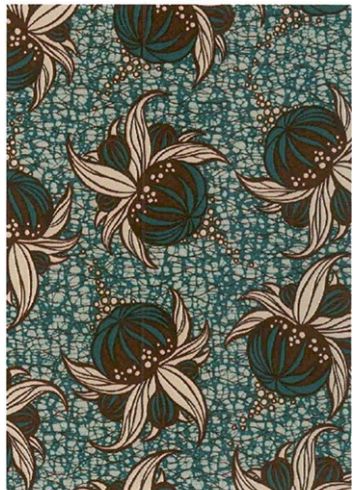

**72.1**

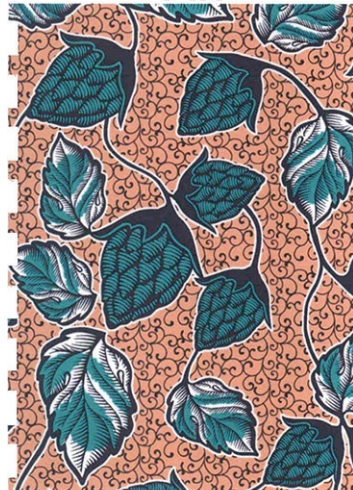

**75.1**



**76.1**

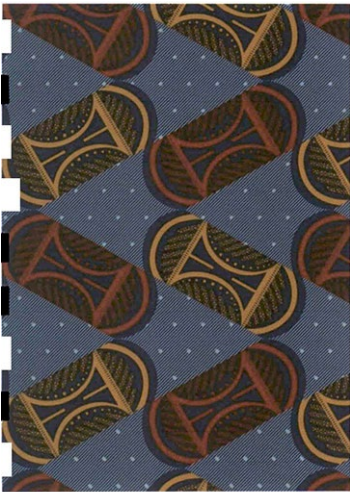

**79.1**

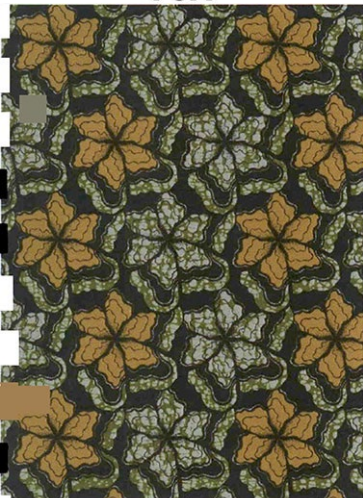

**77.1**



**80.1**

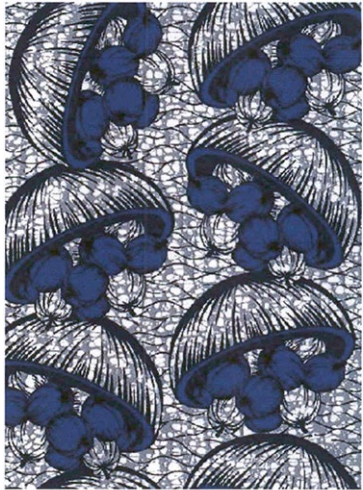

**78.1**



**81.1**

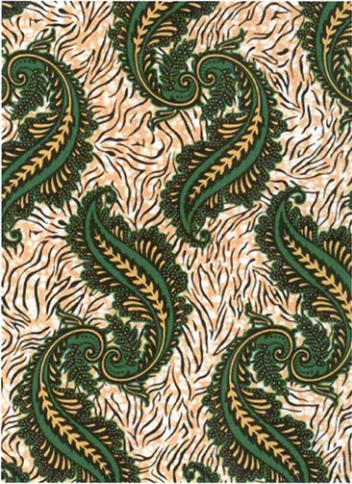

**82.1**



**85.1**

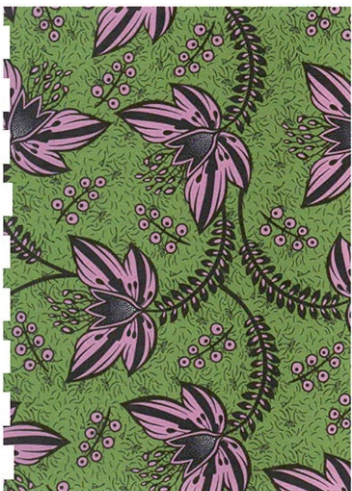

**83.1**



**86.1**

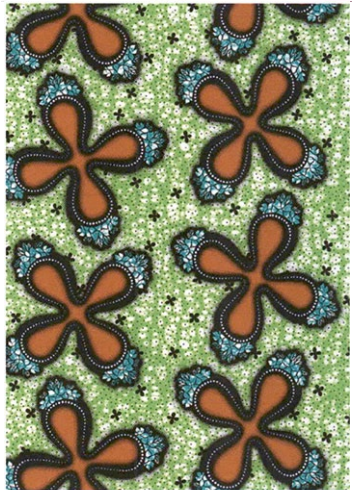

**84.1**



**87.1**



**88.1**



**91.1**

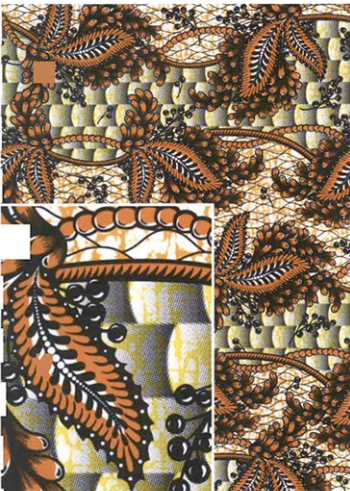

**89.1**

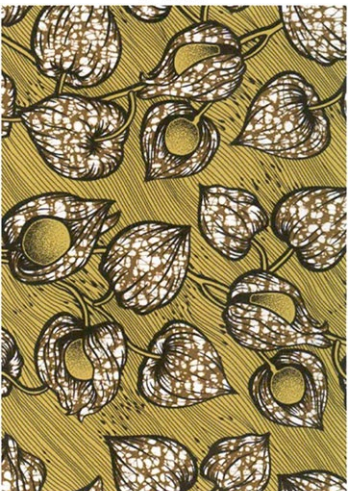

**92.1**



**90.1**

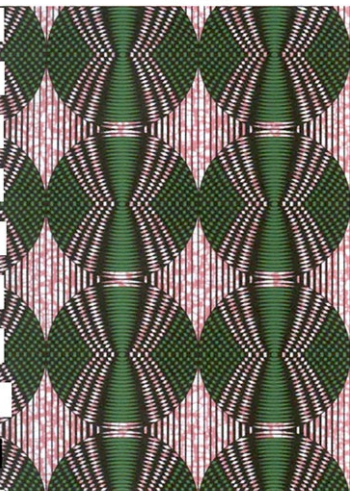

**93.1**



**94.1**

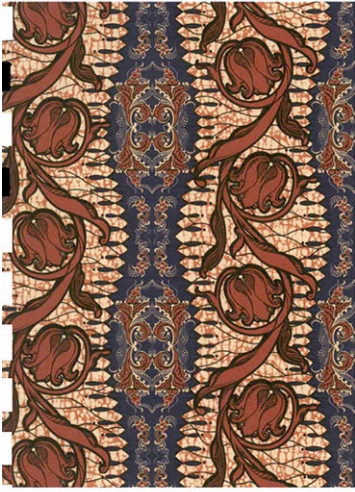

**97.1**



**95.1**

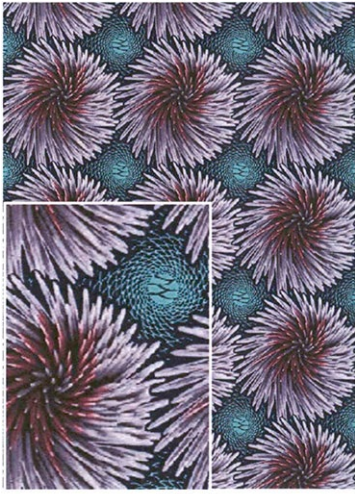

**98.1**



**96.1**

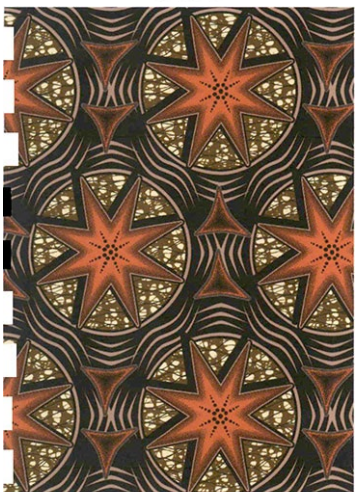

**99.1**



**100.1**

(71) ZHANG XIAO LEI, 01 B.P. 2337,  
ABIDJAN 01 (CI)

**PARTIE III :  
ENREGISTREMENT DES DESSINS ET MODELES INDUSTRIELS  
SELON L'ACCORD DE BANGUI, ACTE DE 1999**

***NEANT***

**PARTIE IV :**  
**ENREGISTREMENT DES DESSINS ET MODELES INDUSTRIELS**  
**SELON L'ACCORD DE BANGUI, ACTE DE 2015**

**7380 à 7402**

(11) 7380  
(21) 4202200237  
(22) 28/10/2022  
(51) 09-01  
(55)

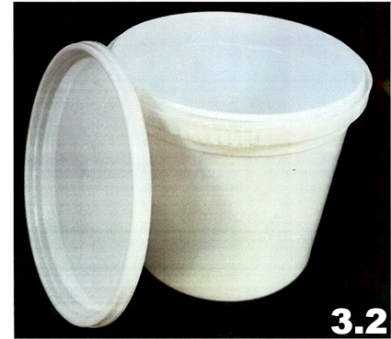



5.2

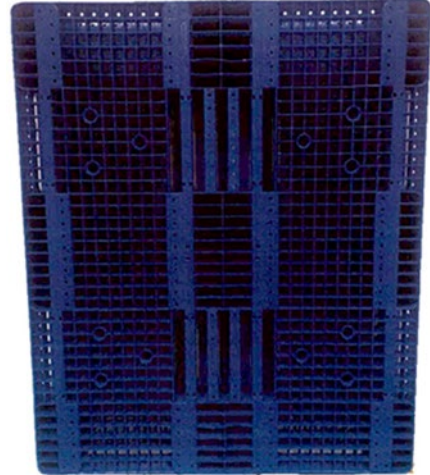

7.2



6.1



8.1

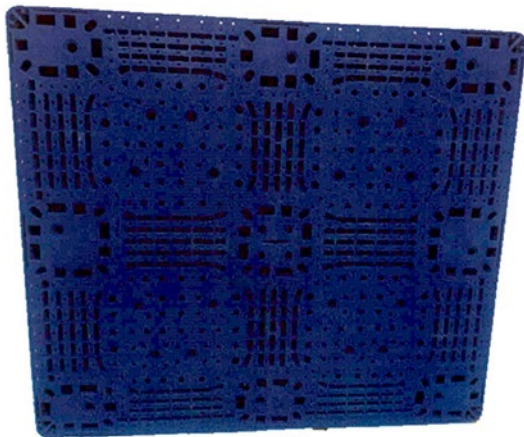

6.2

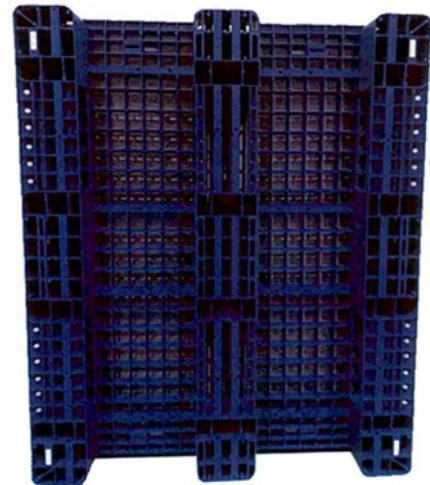

8.2

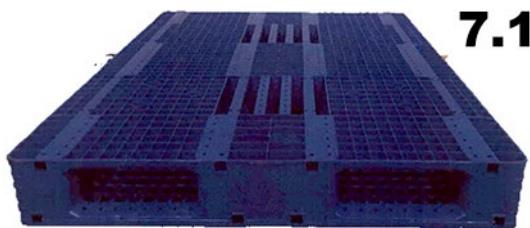

7.1

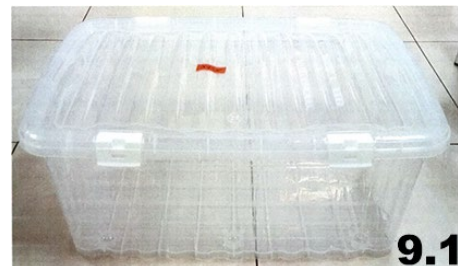

9.1

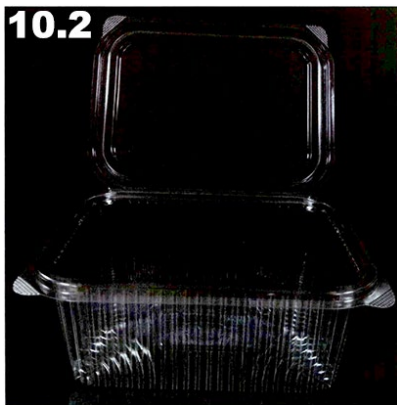

(71) OK PLAST, Yopougon Zone Industrielle, 23 B.P. 932,  
ABIDJAN 23 (CI)  
(72) ALI RAMZI (CI)

(11) **7381**  
(21) 4202400136  
(22) 24/05/2024  
(51) 02-04  
(55)





**3.1**



**4.1**



**5.1**

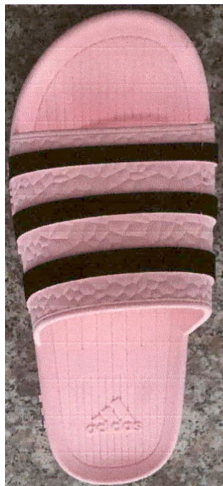

**6.1**



**7.7**



**8.1**



**9.1**



**9.2**



**12.1**



**10.1**



**13.1**



**11.1**



**13.2**

(71) MONSIEUR SADIO BAH, Quartier Madina,  
Commune De Matam, B.P. 3718, CONAKRY (GN)  
(72) BAH SADIO (GN)

(74) CABINET FAOULY BANGOURA ET COMPAGNIE;  
Immeuble Taouyah, carrefour du grand marché de  
Taouyah, près de la Mairie de Ratoma, B.P. 5556,  
CONAKRY (GN)

(11) **7382**

(21) 4202400138

(22) 24/05/2024

(51) 02-04

(55)



**1.1**



**2.1**



**3.1**

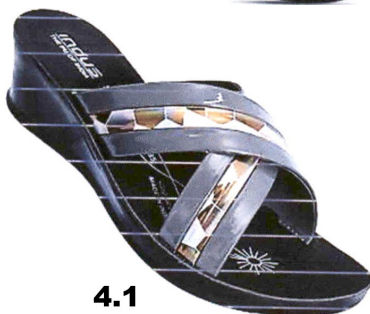

**4.1**



**5.1**



**6.1**

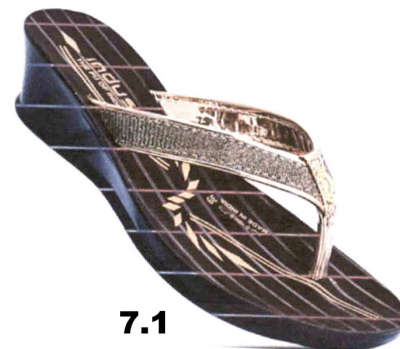

**7.1**



**8.1**



**9.1**



10.1



15.1



11.1



16.1



12.1



17.1



13.1



18.1



14.1



19.1



20.1



26.1



21.1



27.1



22.1



28.1



23.1



29.1



24.1



30.1



25.1



31.1



36.1



32.1



37.1



33.1



38.1



34.1



39.1



35.1



40.1



41.1



46.1



42.1



47.1



43.1



48.1



44.1



49.1



45.1



50.1



**51.1**



**55.1**



**52.1**



**56.1**



**53.1**



**57.1**



**54.1**



**58.1**



**59.1**



**63.1**



**60.1**



**64.1**



**61.1**



**65.1**



**62.1**



**66.1**



67.1



72.1



68.1



73.1

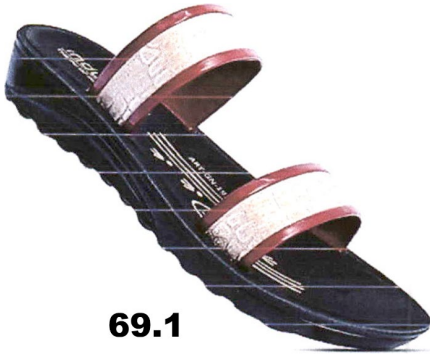

69.1



74.1



70.1



75.1



71.1



76.1



77.1



82.1



78.1



79.1



84.1



80.1



85.1



81.1



86.1

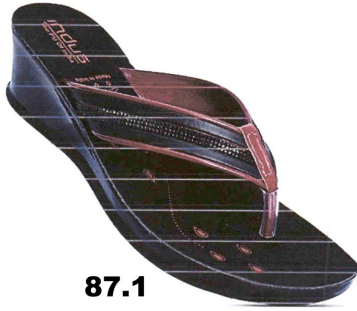

87.1



88.1



89.1



90.1



91.1



92.1



93.1



94.1



95.1

(71) Société TMD GROUP Sarl, Quartier Madina Ecole,  
Commune de Matam, B.P. 2363, Conakry (GN)

(72) DIALLO THIerno MAMADOU (GN)

(74) Cabinet FAOULY BANGOURA & CIE; B.P. 5556,  
CONAKRY (GN)

(11) **7383**

(21) 4202400146

(22) 06/06/2024

(51) 09-03

(54) Boîte [emballages]

(55)



1.1



2.1



3.1



4.4



5.1



6.1



7.1



8.1



9.1

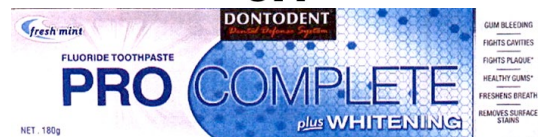

10.1



11.1

(71) Les Établissements DIALLO MAMADOU OURY et FRERES, Madina, Commune de Matam, B.P. 1755, Conakry (GN)

(72) DIALLO MAMADOU OURY (GN)

(74) MOUTHE & ASSOCIES Sarl; B.P. 2764, DOUALA (CM)

(11) 7384

(21) 4202400147

(22) 10/06/2024

(51) 09-03

(54) EMBALLAGE  
(55)

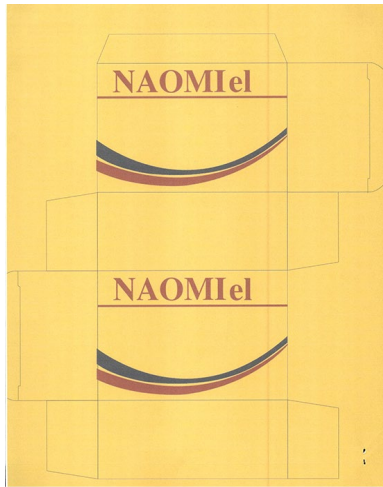

**1.1**

(71) KOFFI YAO KAN Innocent, Yopougon-Koweit, 01  
B.P. 2337, ABIDJAN 01 (CI)  
(72) KOFFI YAO KAN Innocent (CI)

(11) **7385**

(21) 4202400148  
(22) 10/06/2024  
(51) 02-04  
(55)



**1.3**

**1.4**



**1.1**



**2.1**



**1.2**



**2.2**



3.1



5.1



3.2



6.1



4.1



7.1



4.2



7.2



**8.1**



**8.2**



**9.1**



**9.2**



**10.1**



**10.2**



**10.3**



**11.1**

(55)

**11.2****12.1****12.2****1.1****1.2****2.1****2.2**

(71) FCP HIJAZI, Koumassi Zone Industrielle, 06 B.P.  
1741, ABIDJAN 06 (CI)  
(72) HIJAZI MOHAMED (CI)

(11) **7386**  
(21) 4202400149  
(22) 10/06/2024  
(51) 07-07



**3.1**



**3.2**



**4.1**



**4.2**



**4.3**



**5.1**



**6.1**



**6.2**

**7.1****8.1**

(71) KANIA CONSULTING SARL, Adjamé sur  
l'alignement de la Foire de Chine, 18 B.P. 1800,  
Abidjan18 (CI)

(72) BAMBA Kariatou (CI)

(11) **7387**

(21) 4202400150

(22) 10/06/2024

(51) 23-02

(55)

**1.1****2.1****2.2****3.1****3.2**

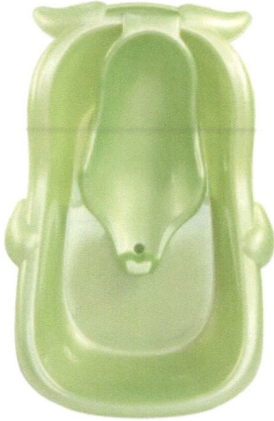

**3.3**



**4.1**



**4.2**

(71) KANIA CONSULTING SARL, Adjamé sur  
l'alignement de la Foire de Chine, 18 B.P. 1800, Abidjan  
18 (CI)  
(72) BAMBA Kariatou (CI)

(11) **7388**

(21) 4202400151

(22) 10/06/2024

(51) 02-04

(55)



**1.1**



**1.2**



**1.3**



**2.1**



**2.2**

**2.3**

(71) SOCIETE GENERALE DE TRANSFORMATION EN  
COTE D'IVOIRE (SOGET-CI), Zone Industrielle de  
Koumassi, 21 B.P. 1382, Abidjan 01 (CI)  
(72) HACHEM HUSSEIN (CI)

(11) **7389**

(21) 4202400153

(22) 10/06/2024

(51) 06-02

(54) Chaises

(55)

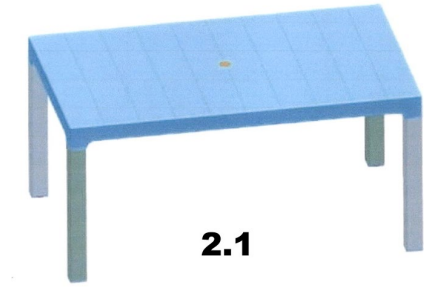
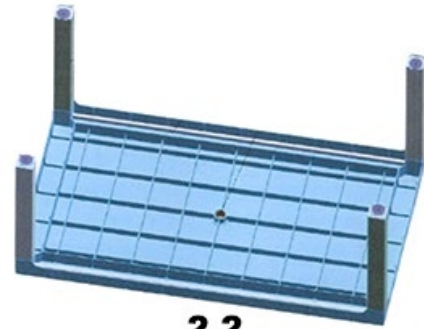
**1.1****1.2****2.1****2.2**

(71) OK PLAST, Yopougon Zone Industrielle, 23 B.P. 932,  
ABIDJAN 23 (CI)  
(72) ALI RAMZI (CI)

(11) **7390**

(21) 4202400154

(22) 10/06/2024

(51) 03-01

(55)

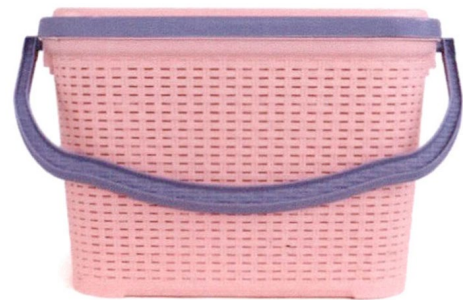
**1.1****1.2**

(55)



1.3



2.1



2.2

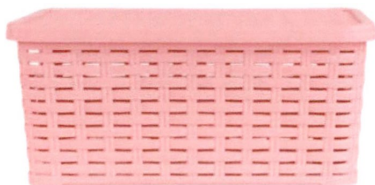

3.1

(71) KANIA CONSULTING SARL, Adjamé sur l'alignement de la Foire de Chine, 18 B.P. 1800, ABIDJAN 18 (CI)

(72) BAMBA Kariatou (CI)

(11) **7391**

(21) 4202400155

(22) 10/06/2024

(51) 02-04



1.1

1.2



1.3

2.1



2.2

2.3

(71) SOCIETE GENERALE DE TRANSFORMATION EN  
COTE D'IVOIRE (SOGET-CI), Zone Industrielle de  
Koumassi, 21 B.P. 1382, Abidjan 01 (CI)  
(72) HACHEM HUSSEIN (CI)

(11) **7392**

(21) 4202400156

(22) 10/06/2024

(51) 19-08

(54) UNE ETIQUETTE

(55)

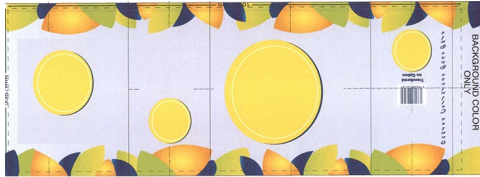

**1.1**

(71) SOCIETE PYPYRUS DE TRANSFORMATION DES  
OUATES DE CELLULOSE DU GABON (SO.PA.T.GA),  
B.P. 16212, Libreville (GA)  
(72) FAKHOURI ONDO PHILIPPE (GA)

(11) **7393**

(21) 4202400157

(22) 10/06/2024

(51) 19-08

(55)



**1.1**



**2.1**



**3.1**

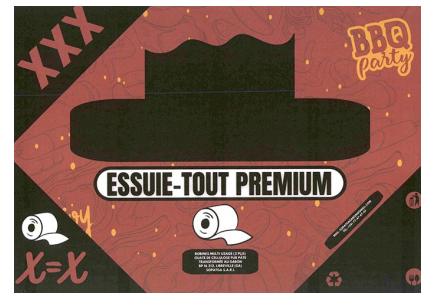

**4.1**

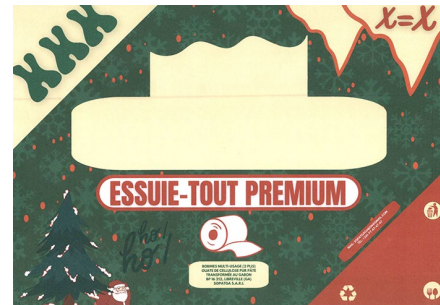

**5.1**

(71) SOCIETE PYPYRUS DE TRANSFORMATION DES  
OUATES DE CELLULOSE DU GABON (SO.PA.T.GA.),  
B.P. 16212, Libreville (GA)  
(72) FAKHOURI ONDO PHILIPPE (GA)

(11) **7394**

(21) 4202400158

(22) 10/06/2024

(30) US n° 29/920,879 du 13/12/2023

(51) 12-08

(54) UTILITY VEHICLE

(55)

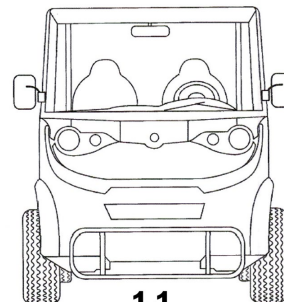

**1.1**

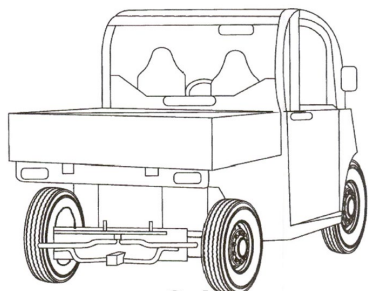

2.1

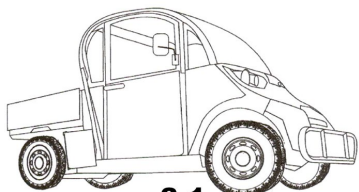

3.1

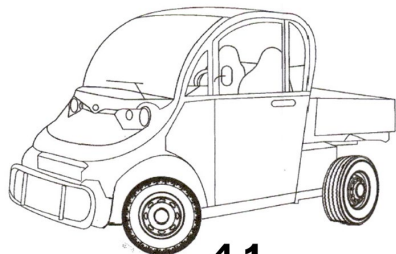

4.1

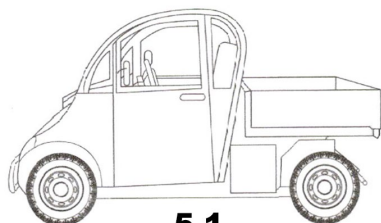

5.1

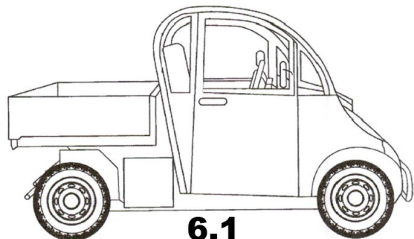

6.1

(71) Waev Inc., 2114 West Ball Road, Anaheim, California  
92804 (US)

(72) James Joseph KENNEY (US)

(74) SCP Cabinet Ngo Minyogog et Associés; Sis derrière  
immeuble ancien FONADER, B.P. 20501, YAOUNDE  
(CM)

(11) **7395**

(21) 4202400159

(22) 10/06/2024

(51) 09-02

(54) Seau de peinture DURCAPLAST

(55)



1.1



2.1



3.1

**4.1****5.1****6.1****7.1**

(71) SEYE Fatou, Cité Douane Golf Nord, Derrière la Station 10 de Camberene, Lot n°41, Dakar (SN)

(72) SEYE Fatou (SN)

(11) **7396**

(21) 4202400161

(22) 18/06/2024

(51) 32-00

(54) LOGO "BOLT" VODKA

(55)

**1.1**

(71) FORTUNE INDUSTRIES, Bonaberi, B.P. 9500, Douala (CM)

(72) DALINAIDU KANCHU (IN)

(74) NGAHANE KEGOUM RAYMOND; Déido - Lieu dit 3 boutiques, B.P. 7384, DOUALA (CM)

(11) **7397**

(21) 4202400164

(22) 21/06/2024

(51) 02-02

(55)

**1.1****2.1**

**3.1****4.1**

(71) AFRICAN FAITH TABERNACLE CHURCH,  
N'zanfouenou, B.P. 143, Kotobi (CI)  
(72) KIRIOUA KANGA (CI)

**(11) 7398**

(21) 4202400165  
(22) 21/06/2024  
(51) 09-05  
(55)

**1.1**

(71) CHANGJIE GAO, 01 B.P. 2337, ABIDJAN 01 (CI)  
(72) CHANGJIE GAO (CN)

**(11) 7399**

(21) 4202400166  
(22) 23/06/2024  
(51) 09-01  
(55)

**1.1**

(71) SOCIETE LMP INDUSTRIES SARL, Quartier Matoto  
Kondebougny, Commune de Matoto, Conakry (GN)  
(72) BAHARANI RAHUL DILEEP SHAROFF (IN)  
(74) Me Francis Charles Kpaga HABA; Rez-de-chaussée  
de l'immeuble Diane, Quartier Sans fil, Commune de  
Kaloum, CONAKRY (GN)

**(11) 7400**

(21) 4202400167  
(22) 25/06/2024  
(51) 05-05  
(54) Tissus  
(55)

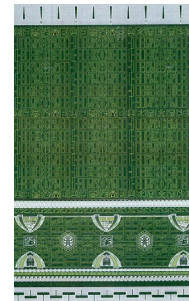
**1.1**

(71) BOTEN BEYAMBAN JOSUE, B.P. 3468, Douala  
(CM)  
(72) BOTEN BEYAMBAN JOSUE (CM)

**(11) 7401**

(21) 4202400168  
(22) 25/06/2024  
(51) 09-01  
(54) Bouteille  
(55)

**1.1****1.2**

(71) OFFICIEL BOISSON AFRICA (OBA), Zone Industrielle, Bamako (ML)

(72) MONSIEUR SABRA JAMIL AREF (ML)

---

(11) **7402**

(21) 4202400169

(22) 25/06/2024

(51) 09-01

(54) Bouteille

(55)



**1.1**



**1.2**

(71) OFFICIEL BOISSON AFRICA (OBA), Zone Industrielle, Bamako (ML)

(72) MONSIEUR SABRA JAMIL AREF (ML)

**PARTIE V :**  
**REJETS DES DEMANDES D'ENREGISTREMENT**  
**DES DESSINS ET MODELES INDUSTRIELS**

***NEANT***

**PARTIE VI :**  
**PROLONGATIONS DES DESSINS ET MODELES INDUSTRIELS**  
***NEANT***

**PARTIE VII**  
**INSCRIPTIONS AU REGISTRE SPECIAL**  
**DES DESSINS ET MODELES INDUSTRIELS**

***NEANT***

**PARTIE VIII**  
**EXTENSIONS DES DROITS**

***NEANT***

**PARTIE IX :**  
**RADIATIONS**  
***NEANT***

**PARTIE X :**

**ERRATA DES DEMANDES D'ENREGISTREMENT  
DES DESSINS ET MODELES INDUSTRIELS  
SELON L'ACCORD DE BANGUI, ACTE DE 2015**

***NEANT***

**PARTIE XI :**

**ERRATA DES ENREGISTREMENTS DES DESSINS  
ET MODELES INDUSTRIELS**

***NEANT***